



V06610

SERVICE
MANUAL

CD-12LE

4822 725 50872

CD-12/DA-12/RC-12CD



marantz®

model CD-12LE

Compact Disc Player System

MARANTZ DESIGN AND SERVICE

Using superior design and selected high grade components, MARANTZ company has created the ultimate in stereo sound.

Only original MARANTZ parts can insure that your MARANTZ product will continue to perform to the specifications for which it is famous.

Parts for your MARANTZ equipment are generally available to our National Marantz Subsidiary or Agent.

ORDERING PARTS:

Parts can be ordered either by mail or by telex. In both cases, correct part number has to be specified.

The following information must be supplied to eliminate delays in processing your order:

1. Complete address
2. Complete part numbers and quantities required
3. Description of parts
4. Model number for which part is required
5. Way of shipment
6. Signature: any order form or telex must be signed otherwise such part order will be considered as null and void.

PARTS ORDERING

Parts may be ordered at the following addresses:

AUSTRIA HORNYPHON Vertriebsgesellschaft GmbH Wienerbergstrasse 1 A 1101 Wien Austria Telex: 132.332	FINLAND MARANTZ DIVISION OF OY PHILIPS Ab Kaivokatu 8 00100 Helsinki Finland Telex: 124811	GREAT BRITAIN MARANTZ AUDIO U.K. Ltd Unit 15/16 Saxon Way Industrial Estate Moor Lane Harmondsworth UB7 0LW Great Britain Telex: 935196	SAUDI ARABIA AL ALAMIAH ELECTRONICS P.O.Box 5954 University Street Riyadh 11452 Saudi Arabia Telex: 401530	SWITZERLAND DYNAVOX ELECTRONICS Route de Villars 105 1701 Fribourg Switzerland Telex: 942377
BELGIUM SVD DIVISION MARANTZ Industrialaan 1 1720 Groot-Bijgaarden Belgium Telex: 24466	FRANCE MARANTZ FRANCE 4 Rue Bernard Palissy 92500 Asnières France Telex: 611651	GREECE SHERTON ELECTRONICS S.A. P.O.Box 21025 Hippokratous Street 188 Athens 11471 Greece Telex: 216.795	SOUTH AFRICA MARANTZ DIVISION OF PHILIPS S.A. Main Road Martindale P.O. Box 58088 Newville 21114 South Africa	TURKEY DOGRUOL Ltd. I.M.C. 6 Blok N°6310 Unkapani Istanbul Turkey Telex: 22085
CHILE MARANTZ DIVISION OF PHILIPS S.A. AV. Santa Maria, 0760 Casilla 2667 Santiago Telex: 240.238	GERMANY MARANTZ GERMANY GmbH Max-Planck-Strasse 22 6072 Dreieich 1 Germany Telex: 529821	JAPAN MARANTZ JAPAN, Inc. 35-1, 7-chome, Sagamino Sagamihara-shi, Kanagawa Japan	SPAIN PHONO S.A. Ignacio Iglesias 10 Badalona (Barcelona) Spain Telex: 59355	MALTA CACHIA & GALEA Republic Street, 68D Valletta Telex: 1682
DENMARK MARANTZ DIVISION OF PHILIPS SERVICE A/S Prags Boulevard 80 Postbox 1919 DK-2300 København S Denmark Telex: 31201	THE NETHERLANDS Eipro Marantz Wint Hortlaan 28 3526 KV Utrecht The Netherlands Telex: 4748	KUWAIT AL ALAMIAH ELECTRONICS Ussama Building Fahd al Saleem Street P.O.Box 23781 Safat-Kuwait Telex: 22694	SWEDEN MARANTZ DIVISION OF PHILIPS Försällning AB Tegeluddsvägen 1 S-115 84 Stockholm Sweden Telex: 14060	PORTUGAL MARANTZ Divisao philips S.A. service Ourela-carnaxide 2795 Linda-A-VELHA Telex: 43906
	NORWAY MARANTZ DIVISION OF PHILIPS A/S Sandstuveien 40 0680 Oslo 6 Norway Telex: 72640	ITALY MARANTZ ITALIANA S.P.A. Via Chiesa, 74 20126 Milano Italy		

All of the above locations are fully equipped to take care of your total service needs. Because various countries have differing configuration requirements, it is necessary that you contact the service facility in your particular country. In the event that there is no service location listed for your country, please, contact the nearest facility for the necessary assistance.

In case of difficulties, do not hesitate to contact the Technical Department at abovementioned address.

TABLE OF CONTENTS

INTRODUCTION	3
1. P.W. BOARDS	4
2. LASER RADIATION SAFETY	4
3. NOTES ON ELECTROSTATIC DAMAGE	5
4. TRANSPORTATION SCREWS	5
5. CD-12	6
ELECTRICAL MEASUREMENT AND DJUSTMENTS	6
INITIATION OF THE SERVICEING ROGRAMME OF THE μ P.	6
FAULTFINDING METHOD	7
PRACTICAL HINTS	7
DETAILED TROUBLESHOOTING METHOD	8
LOADING TRAY MECHANISM	20
6. DA-12	22
ANALOGUE MUTING	22
INPUT/TAPE MONITOR CHANGEOVER	24
JITTER KILLER CIRCUIT	25
7. CD-12 COMPONENT LOCATIONS	27
8. DA-12 COMPONENT LOCATIONS	30
9. RC-12CD COMPONENT LOCATIONS	34
10. CD-12 EXPLODED VIEW AND PARTS LIST	36
11. CD-12 ELECTRICAL PARTS LIST	42
12. DA-12 EXPLODED VIEW AND PARTS LIST	46
13. DA-12 ELECTRICAL PARTS LIST	50
14. RC-12CD EXPLODED VIEW AND PARTS LIST	54
15. RC-12CD ELECTRICAL PARTS LIST	56
16. TECHNICAL SPECIFICATIONS	58
17. SCHEMATIC DIAGRAM	59

How to use this service manual

- The "Common parts" which Marantz Japan, Inc. has established are eliminated from this service manual.
- These "Common parts" are applied to all models in the service manuals arranged and issued by MJI.
- To indicate clearly the common parts in the schematic diagram, a line is drawn above or under the Ref. Desig. No. of applicable parts.
- "Common parts" can be supplied from the Marantz service center as ever.
In case of ordering, please establish the parts number of 12 N/C'S following the procedure mentioned in this service manual "How to establish the parts number for common parts".

- 1) Please correctly write the parts number of 12 N/C'S following the rule.

COMPACT DISC SYSTEM CD-12LE

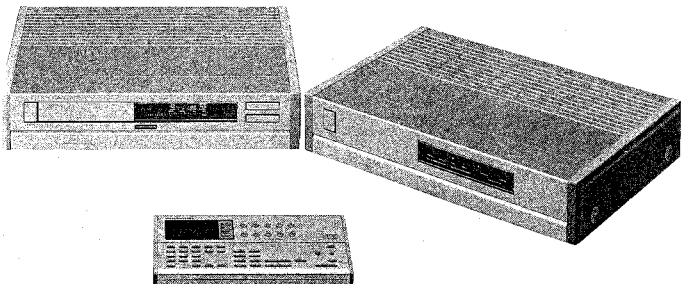

**CLASS 1
LASER PRODUCT**

INTRODUCTION

This service manual are prepared for use by Authorized Warranty Station and contains service information for Marantz Compact Disc System.

Servicing information and voltage data included in this manual are intended for use by the knowledgeable and experienced technician only. All instructions should be read carefully. No attempt should be made to proceed without a good understanding of the operation of the Compact Disc System.

The parts list furnishes information by which replacement parts may be ordered from the Marantz Company. A simple description is included for parts which can be usually obtained through local suppliers.

1. P.W.BOARDS

As can be seen from the circuit diagram, the chassis of your Compact Disc System consists of the following units. Each unit mounted on a printed circuit board is described within the square enclosed by a bold dotted line on the circuit diagram.

Model CD-12

1. POWER/DEMO mounted on P.W. Board PD16
2. FEATURE μ -COM mounted on P.W. Board PM16
3. POWER SWITCH mounted on P.W. Board PP46
4. TEN KEYS mounted on P.W. Board PS26
5. SERVO mounted on P.W. Board PV16
6. SERVO MODULE mounted on P.W. Board PV26
7. DISPLAY mounted on P.W. Board PY16

Model DA-12

1. AUDIO DAC mounted on P.W. Board PA16
2. BALANCE AMP mounted on P.W. Board PA26
3. DEMO mounted on P.W. Board PD16
4. POWER SWITCH mounted on P.W. Board PP26
5. DIGITAL IN/OUT mounted on P.W. Board PJ16
6. POWER SUPPLY mounted on P.W. Board PP16
7. FUNCTION SWITCH/
PHONE mounted on P.W. Board PS16

Model RC-12CD

1. MAIN mounted on P.W. Board P506
2. KET mounted on P.W. Board P606

MEASURING EQUIPMENT AND TEST DISC REQUIRED FOR SERVICING

- DC voltmeter
- Distortion meter
- Low pass filter
- Spectrum analyzer
- Oscilloscope
- Phase meter
- Frequency counter
- Test disc

2. LASER RADIATION SAFETY

Protection of eyes from laser beam during servicing. This set employs a laser. Therefore, be sure to carefully follow the instructions below when servicing.

1. Laser Diode Properties

- Material: Al Ga As
- Wave Length: 0.78 μ m
- Emission Duration: Continuous
- Laser Output: Max. 0.11 mW

This output is the value measured at the objective lens surface on the light pen assembly.

- Classification: Class IIIB

2. During service, do not take the subchassis block apart and do not adjust the H F amp circuit. If there is a breakdown in the H F circuit (including laser diode), replace the entire subchassis block (including H F amp circuit board).

WARNING!!

When servicing, do not approach the laser exit with the eye too closely.

In case it is necessary to confirm laser beam emission, be sure to observe from a distance of more than 30 cm from the surface of the objective lens on the light pen assembly.

3. NOTES ON ELECTROSTATIC DAMAGE

When handling the laser diode of the optical pick-up or the MOS IC, be sure not to damage them with electrostatic. The electrostatic level charged in the human body and clothing varies with ambient conditions. However, simply walking will produce an electrostatic charge of more than several kV. With synthetic fiber clothing, an electrostatic charge of about 10 — 30 kV will be produced on a dry day. If the charged electrostatic voltage is applied to the electrode of the semi-conductor, the electrode may be damaged easily. When handling the laser diode or the MOS IC, pay attention to the following points.

1. Lay a conductive sheet on the work bench and ground it.
2. Ground the soldering iron.
3. Do not wear synthetic fiber gloves or clothing. During operation, be sure to put on the wrist strap shown below.

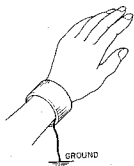

4. Use a conductive material to store the semi-conductors and short-circuit the electrodes or wrap them in aluminium foil to keep the potential at each electrode the same.

4. TRANSPORTATION SCREWS

To prevent the laser pick-up from damage during transportation, the pick-up is secured with two screws. After unpacking, be sure to remove two screws. After servicing, do not forget to fix the laser pick-up with two screws.

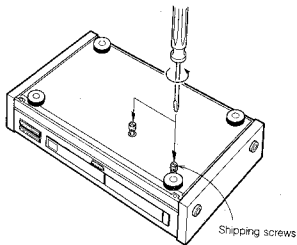

5. CD-12

ELECTRICAL MEASUREMENTS AND ADJUSTMENTS

Specification measurement



To measure the specification use can be made of audio test disc 4822 397 30085.

Use a 7th order filter, e.g. 4822 395 30204 (see Figure), to measure:

- Total harmonic distortion (THD).
- Intermodulation distortion.
- Signal-to-noise (S/N).

Laser power supply (POS. VOLT. SH.)

For check and preliminary adjustment of the laser supply see service manual C.D.M.-1.

Adjusting the laser supply

Play track 1 of test disc 4822 397 300096 (disc without defects).

Connect a DC voltmeter across resistor R309 on the servo PCB (= on emitter of transistor Q315 and ground).

Adjust the laser power supply with resistor 3180 until the voltage across resistor R309 is 575 ± 75 mV.

Adjusting the focus bandwidth

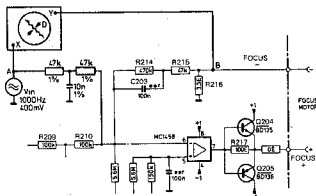

Make a measuring arrangement according to the figure.

Play track 1 of test disc 4822 397 300096 (disc without defects).

Adjust trimming resistor 3158 on PRE. AMPL + LASER PCB for a 180° phase difference between signals A and B. This corresponds with a minimum distance D in the Lissajous pattern.

R=47 k Ω - 1% 5322 116 54671

C=10 nF - 1% 5322 121 54154

Check of the AGC and offset circuits

(See SERVO PCB)

Play track 1 of test disc 4822 397 80096 (Disc without defects).

The voltage between pin 7 of IC Q303 (4/4) and \perp should be $-4 \text{ V} \pm 2 \text{ V}$.

The voltage between pin 8 of IC Q302 (2/4) and \perp should be $0 \text{ V} \pm 2 \text{ V}$.

INITIATION OF THE SERVICING PROGRAMME OF THE μP

— Servicing position "0"

Simultaneously depress the STOP, PLAY and SEARCH \Rightarrow buttons. Keep these three buttons depressed while the mains voltage is switched on. This is the STAND-BY mode, "0" appears on the display.

In this state it is possible to move the arm by means of the SEARCH FORW and SEARCH REV keys with a minimum torque to the outside and the inside resp.

This enables a check of the free motion of the arm across the disc.

— Servicing position "1"

From servicing position "0" the player can be brought in servicing position "1" by depressing the NEXT key.

In this state the laser emits light and the objective starts to focus. When the focal point has been reached, "1" appears on the display.

When no disc has been inserted the objective goes 16 x to and fro. Then the player reassumes servicing position "0".

As in servicing position "0" the arm can be moved across the diameter of the disc by means of the SEARCH FORW and SEARCH REV keys.

— Servicing position "2"

To be reached by depressing the NEXT key after servicing position "1" has been reached.

The turntable motor starts to run

On the display appears "2".

In preparation of the transition to servicing position "3" the arm is sent to the centre of the disc.

— Servicing position "3"

To be reached by depressing the NEXT key after servicing position "2" has been reached.

The radial control is switched on. The subcode information is ignored. MUSB is high so that the music information is released.

On the display appears "3".

(Dependent on the length of the lead-in track music will be reproduced after approx 1 min.)

In this state it is possible to move the arm by means of the SEARCH FORW and the SEARCH REV keys to the outside and to the inside resp. Now the motion is controlled by the μ and the arm moves by steps of 64 tracks as long as the key is depressed.

If one of the servicing positions 1, 2 or 3 is disturbed (e.g. braking or removing the disc) the player resumes servicing position "0".

The servicing programme can be left by switching the mains switch (POWER ON/OFF) off and on. (Hardware reset).

FAULTFINDING METHOD

Preface

In course of the development of the troubleshooting guide for the Compact Disc it has become clear that a different approach from the one applied so far was required.

For, it is no longer possible to use the classic strategy, i.e. basing the troubleshooting method on a number of possible faults in the unit.

Practice has shown that a certain fault, with the associated symptom, can have a wide variety of causes. The reason is that this player incorporates a number of feedback loop configurations—which, moreover, might affect each other—and this impedes the obvious measurements.

The method below divides the player from diagram point of view into nine clearly distinguishable sub-groups and by performing some measurements, the sub-group being in failure can be isolated. Later the defective circuit can be further examined according to the method given.

PRACTICAL HINTS

Test discs

It is important to handle the test discs with great care. For, the troubles (black dots, fingerprints, etc.) are exclusively and unambiguously positioned. Damage can cause additional drop-outs etc. and as a result the conscious fault on this disc is no longer exclusive.

In that case it is no longer possible to check e.g. whether the track detector is working correctly.

Measurements on op-amps

In the electronic circuits of the servo systems op-amps are frequently being applied. These op-amps can be used as amplifiers, as filters, as invertors, as buffers, etc.

In those cases where feedback is applied in one way or the other, the voltage difference at the differential inputs inclines to zero. This applies both to DC and to AC.

The cause can be traced back to the properties of an ideal op-amp ($Z_i = \infty$; $G = \infty$; $Z_o = 0$).

In practice this means that it is nearly impossible to perform measurements on the inverting and non-inverting inputs of op-amps if one input is directly connected to ground.

In those cases only the output signal will be measurable.

That is why in most cases no AC voltages can be given to the inputs.

The DC voltages at the inputs are equal.

Stimulating with "0" and "1"

In the troubleshooting method certain pins should in a number of cases be connected to ground or be connected to the power supply voltage.

This way of acting offers the possibility to overrule certain circuits and to stimulate others.

In this way the diagnose time can be reduced.

In a number of cases the relevant pins appear to be **op-amp outputs**.

In this respect it should be mentioned that the outputs of the used op-amps are short-circuit protected.

This implies that the output of an op-amp can be made low (= usually ground potential) without consequences.

On the other hand should be pointed out that it is **not allowed** to connect the output of an op-amp directly to the **power supply voltage**.

I/Os of microprocessors should not be connected directly to power supply voltage.

These I/Os are allowed to be brought to "0" in case this is mentioned explicitly.

Selection of ground point

It is very important to select a ground point as close as possible to the test point.

Conditions for injecting

- It should be pointed out that injection of levels or signals from a strange source is **never** allowed to occur when the power supply voltage is lacking in the circuit in question.
- Naturally, the injected level is never allowed to exceed the power supply voltage of the circuit in question.

Continuous burning of the laser

- Disconnect plug J203 on the servo PCB and connect pin J203-9 (laser) of the cable connector to ground.

Now the focus loop and the radial loop are interrupted as well:

J203-7 (RE1 = Radial Error 1), J203-8 (RE2 = Radial Error 2) and J203-10 (FE = Focus Error).

The laser also burns continuously when the set is in service loop 2.

Irregular working of the display

Irregular working of the display when the set is opened and playing, might have been caused by incidental body effect in the region of the crystal oscillators.

Switching "off" and "on" of the mains voltage will eliminate this effect.

Indication of checkpoint

In the circuit diagram the checkpoints have been given a serial number (e.g. 12), to which the troubleshooting method will refer.

For oscillograms, amplitudes, time bases and position of set, see tables of checkpoints.

GENERAL CHECKPOINTS

In the detailed troubleshooting method following below a number of general conditions, required for proper functioning of the player, will **not** be repeated. Before starting the detailed troubleshooting method these general points should be checked.

- Ensure that disc and objective are clean (remove dust, fingerprints, etc.) and use undamaged discs.
- Convince yourself of the presence of the clock frequencies, viz:
 - 12 MHz for μP servo (pin 18)
 - 11.2896 MHz for FILTER-B IC (pin 19)
 - 2.82-5.64 MHz for free-running PLL circuit on the DECODER-A IC (pin 27)
 - 3 MHz for control and display μP (pin 33).
- Check whether all power supply voltages are present and have the correct level.
See PCB drawings.
- Check whether the two mutes (KILL and MUSB are inactive so that data are nowhere interrupted. This should go high about 2 seconds after the mains voltage is switched on.
MUSB=pin 23 of the FILTER-B IC on the decoder PCB.
Normally this pin is high during play and low during search.

DETAILED TROUBLESHOOTING METHOD

A number of quick and efficient checks immediately give a definite answer on poorly functioning sections of the player.

To check the servo systems four service loops have been built in μP Q271.

Before calling in service loops, it should be checked (position power on) whether the bus (clock, data: pin 17 and 10 or 11 of μP Q271 resp.) is free. In other words, checking whether these lines do not have a short circuit to ground or supply voltage (level low or "high"). In such a case the buttons cannot be operated.

For troubleshooting the step-by-step method below is followed.

First step (with disc on turntable)

Bring the player in service loop 1 or 2

If one of the conditions for service loop 1 or 2 is not met, the questions below should be answered positively in the sequence given.

In practice this means that when one question has been answered positively, all the preceding circuits, to which the questions refer, are functioning well.

Example: if the eye pattern is present, we may conclude that the laser is working, the laser is in focus and that the turntable motor is running.

Note:

In some situations, certain faults in the radial servo circuit affect the focus servo circuit (e.g. if supply voltage + 1 of IC Q301 in the radial circuit fails, the focus coil starts oscillating).

To determine if this situation exists, connect point 46 on the servo PCB to ground.

In this way, the influence of the radial servo circuit on the focus servo circuit can be eliminated.

- Is the laser giving light?
(Test method: see sub A)
- Is the angle disc-light pin within the tolerance, i.e. $90^\circ \pm 0.5^\circ$?
(Test method: see description mentioned in chapter "Mechanical measurements and adjustments" of the C.D.M. manual).
- Is the laser giving sufficient light?
(Test method: see sub C).
- Does the objective come in focus?
(Test method: see sub D).
- Is the turntable motor running and, if so, is it running at the correct speed?
(Test method: see sub E).

If the answers to questions 1 or 2 through E are positive, it should be possible to bring the player in service loop 1 or 2.

Second step (with disc on turntable)

Bring the player in service loop 3.

This means that the eye pattern on point 46 (on the decoder PCB has to be stable, while MSC on point 47 on the servo PCB has to be more stable too).

(Test method: see DECODER-A IC)

Note that the set is not only tracking a song in loop 3, but also playing the song, provided the digital circuit is working (however music cannot be hard).

If this does not work, return to service loop 2 and answer the questions below positively in the sequence given.

- Are \overline{DO} and HFL detectors functioning?
(test method: see sub F)
- Is track detector functioning?
(test method: see sub G)

H. Is the radial control functioning properly?
(test method: see sub H)

If the answers to questions F, G and H are positive, it should be possible to bring the player in service loop 3.

Third step (with disc on turntable)

Note that the set is not only tracking a song in loop 3, but also playing the song, provided the digital circuit is working (music cannot be heard).

If this does not work, return to service loop 3 and answer the question below positively.

I. Is TL functioning, i.e. polarity of RE?
(test method: see sub I)

J. Is information transmission subcode functioning?
(test method: see DECODER-AIC)

Check the Q-channel signals.

If the answers to questions I and J are positive, it should be possible to bring the player in the Play mode.

Fourth step (with disc on turntable)

If no music is heard in position "play" or service loop 3 answer the last question.

K. Is digital decoder circuit functioning according to specification (test method: see II. FILTER-B IC and V. KILL CIRCUIT)

Sub. A. IS THE LASER GIVING LIGHT?

Test method

Bring the player in service loop 1 without placing a disc on the turntable. Now the laser is giving light for an unlimited period of time.

Another method for which the laser gives light during an unlimited period of time and the objective is standing still, is disconnecting plug J203 on the servo PCB and connecting point J203-9 of the cable connector to ground.

In case of power-on the laser should burn. This is checked with the aid of a light-sensitive component which is slightly screened from ambient light.

Hereafter follow some examples:

a. Connect photosensitive diode type BPW4, code number 4822 12032108, with correct polarity to an analogue multimeter (e.g. PM2412) at range 10 k Ω .

If the laser is burning, the meter will give virtually full scale deflection.

b. Connect LDR, code number 4822 116 10002, to digital multimeter PM2517E.

If the laser is burning, the resistance will drop to approx. 8 k Ω .

If the laser is not giving any light, proceed to Annex 1.

Sub. C. IS THE LASER GIVING SUFFICIENT LIGHT?

Test method (Test points on Pre-amp PCB)

— interrupt the collector of Q203 on the servo PCB or ground the side of electrolytic capacitor C201. Disconnect plug J203 on the servo PCB and connect pin **J203-9 (laser)** of the cable connector to ground.

Now the laser should continue to give light while FE, RE1 and RE2 are interrupted.

— Place disc on turntable and switch power on.

— Directly inject with AF generator ($Z_1 \leq 600$ Ohms) to test point $\diamond 1$ FE a sine-wave signal between 25 and 60 Hz (exact frequency is player-dependent) and 2V_{pp}.

— Select such a frequency that the monitor diodes of the light pin give output signals as indicated on test points $\diamond 5$, $\diamond 6$, $\diamond 7$ and $\diamond 8$. Amplitude 40–80 mV.

— If the amplitude is not sufficient, proceed to Annex 1.

Sub. D. IS THE OBJECTIVE COMING INTO FOCUS?

Test method

● No disc on turntable

Switch power on and actuate Play button.

Now the arm should move inwards. Immediately after that the objective should move two times up-and-downwards (this happens during searching of the focusing point).

After this the action will stop.

These actions are software-controlled from the servo μ P. If this is not working, check μ P servo, end stage focus circuit or focus coil.

● With disc on turntable

Quick test procedure:

For a rough check on the working of the focus circuit, proceed as follows:

— place disc on turntable.

— set player in service loop 1.

— remove disc from turntable.

— now examine if the objective focuses by bringing a reflective object (e.g. mirror) above it.

Detailed test procedure

— Check **Q203** (on servo PCB) as follows:

Check whether FN becomes, with each passage of the nominal focusing **low** for a **short period of time**. Only when focusing point FN has been found, FE will be released via Q203 (base will become negative).

Check whether base of Q202 is driven low from servo μ P (= FCO). If not, check servo μ P. If so, proceed.

— Test focusing circuit as follows:

Interrupt the collector of Q203 on the servo PCB and disconnect **plug J203** on the servo PCB. Con-

nect pin **J203-9 (laser)** of the cable connector to ground.

Now the laser is burning continuously, FE has been released and the focus loop has been interrupted at test point \diamond (=FE) on servo PCB.

Testing of circuit, between test point \diamond and focusing coil

(Test points on servo PCB)

- Directly inject a sine-wave signal of 10 Hz, $2V_{pp}$, to test point \diamond by means of an AF generator ($Z_1 \leq 600 \Omega$).
- Check visually whether focusing coil "--" and thus objective too "--" responds.
- Check whether this voltage is $0.6 V_{pp}$ on test point \diamond .
- Check whether this voltage is $6 V_{pp}$ on test point \diamond .
- Check whether this voltage is $5 V_{pp}$ on test point \diamond .

Testing the subchassis (Test points on Pre Amp PCB, injection point on servo PCB)

- Place a disc on the turntable.
- Directly inject to test point \diamond a sine-wave signal between 25 Hz and 60 Hz at $2 V_{pp}$ by means of an AF generator ($Z_1 \leq 600 \Omega$). The exact frequency is player-dependent.
- Select such a frequency that the monitor diodes of the light pin give output signals as indicated on test points \diamond , \diamond , \diamond and \diamond .
- Check test points \diamond , \diamond , \diamond and \diamond .
- Check test point \diamond .
- Check test point \diamond .

Is the same as signal on test point \diamond but amplitude is dependent on position of potentiometer 3138.

If all the checks are positive, close focus loop (insert plug J203). Now the focusing circuit should be able to operate. Reconnect transistor Q203.

It should be noted here that the amplitudes on test points \diamond through \diamond are slightly dependent on the characteristic of the monitor diodes.

Sub. E. IS TURNTABLE MOTOR RUNNING AND, IF SO, IS IT RUNNING AT THE CORRECT SPEED?

Test method (Test points on servo PCB)

- Place disc on turntable and bring set in service loop 2.
- If focusing point is found, check whether FCO is low on point \diamond .
If not, check focus circuit sub D.
If so, proceed.
- Now only power on, disconnect plug J201 on the servo PCB and check MSC=point \diamond of cable connector J201 or point \diamond on the decoder PCB.

If not, check Decoder-A IC (Q501) circuit.
If so, proceed.

- Reconnect plug J201, disconnect plug 15 on the preamplifier PCB and inject a DC signal to the cable connector of the motor or directly to the turntable motor.

The turntable motor should be running now.

(A DC voltage of 2.5 V approximately corresponds with the rpm during scanning of the innermost tracks).

In this condition the player should be brought in service loop 2 (depress Stop button while mains voltage is switched on).

If DC < 2.5 V Figure G should be visible on test point \diamond (servo PCB).

If DC > 2.5 V Figure H should be visible on test point \diamond .

If so, check turntable control circuit (circuit from point \diamond to turntable motor).

If not, check whether MSC is released by means of SSM at pin 16 of IC Q271.

This connecting plug J201 on the servo PCB and measure on pin 12 of cable connector J201.

If MSC is working now, check circuit around IC Q271.

- Take player out of service loop 2, depress Power-on button and then Play button and check eye pattern on point \diamond (on decoder PCB).

To stabilize the eye pattern, bring light pin above tracks by hand, or by briefly (5 s) depressing Fast Forward button.

If eye pattern not point \diamond is not present or unstable, check RF pre amplifier (see Annex IV).

- If eye pattern is correct, proceed.

- Check whether point \diamond (=HFLS) on the servo PCB is correct in service loop 2 (see Figure Y). If not, check HFLS detector circuit (is circuit between point \diamond and \diamond). If so, proceed.

Take player out of service loop 2 by depressing the power button.

- Check locking-in of PLL circuit of Decoder-A IC. (See CEFM signal pin 27: point \diamond)

If PLL is locking-in, proceed.

- Check timing signals on output of Decoder-A IC as indicated in "DECODER-A IC".

Is the digital decoder circuit functioning according to specification? If timing signals are correct, proceed.

- If MSC is still not functioning properly, replace the relevant specific digital IC according to the trial and error method with the aid of service IC box.
- MSC has to be present now.

Sub. F. ARE THE DO and HFLS DETECTORS FUNCTIONING?

Test method (Test points on servo PCB)

- Starting point is:
HFLS = 1 when spot is exactly on track
HFLS = 0 between tracks (e.g. during track jumping)
DO = 0, or DO = 1 in case of drop-out
DO = 1, or DO = 0 when there is no drop-out.

Approximative method

(applicable in service loop 2)

- Place disc on turntable.
- Bring player in service loop 2.
- Check whether DO (test point ④) is not continuously "high". Normally test point ④ is "low", however small spikes of approximately 100mV are present in case of scratches on the disc.
- Check HFLS (test point ⑤).

Precise method

(can be checked in playing set only)

- Place test disc 5A on turntable. Switch power on and depress Play button.
- Select track no. 10: Check point ④. HFLS pulses should be present.
- Select track no. 15: Check point ④. DO pulses should be present. With this track the HFLS pulses on point ④ should also be present.
- In case of track jumping HFLS pulses are always present on point ④.

Sub. G. IS TRACK DETECTOR FUNCTIONING WELL?

Test method (Test points on servo PCB)

Switch off the offset circuit:

Loosen resistor 3315 (at the side where it is in contact with pin 8 of IC Q302).

Mount a 47 kΩ trimming potentiometer between +1 and -1 supply voltage (for example between pins 4 and 11 of IC Q302). Connect the wiper of the trimming potentiometer to the loose side of resistor 3315.

- Place a disc on the turntable.
- Bring the set in service loop 2.
- Adjust the signal on test point ④ symmetrically round 0V by means of the external 47 kΩ trimming potentiometer. The amplitude of the signal may change during this adjustment.
- Measure F.S on point ④.
Here too the frequency variation depends on the eccentricity of the disc.
- Check point ④.
- Check point ④. Signal cannot be triggered.
- Check point ④.
- Switch the offset circuit on again.

Sub. H. IS THE RADIAL CONTROL FUNCTIONING PROPERLY?

Attention: The offset circuit (d-multiplier) and the AGC circuit (k-multiplier) are correction circuits. This means that under optimal conditions (new disc, minimum tolerances of components) the set may be working properly even if a fault is preset in offset or AGC circuit.

Test method (Testpoints on servo PCB)

- Place disc on turntable.
- Switch off AGC circuit (k-multiplier) and switch off offset circuit (d-multiplier).

Method:

Switching off AGC circuit: interconnect points ④ and ④ of IC Q309.

- Place a disc on the turntable.
- Bring the set in service loop 2.
- Adjust the signal on test point ④ symmetrically round 0V by means of the external 47 kΩ trimming pot. The amplitude of the signal may change during this adjustment.

- Bring set in service loop 3.
At this moment there is a high probability that the set is working.
If so, check d and k factor (see Annexes II and III).
If not, proceed.

- Bring set in service loop 2 and check signal on point ④.

The AC-component has to be 12-14 V symmetrically, around a DC level of zero volt.

If this is correct, proceed to e).

If this is not correct check following testpoints

- ④, ④: value should be 0.7 V_{pp}
- ④: value should be 0.2 V_{pp}
- ④: value should be 0.25 V_{pp}
- ④: value should be 20 mV_{pp}
- ④, ④: value should be 800 mV_{pp}

Note:

The frequency variation strongly depends on the eccentricity of the disc.

If points ④ + ④ are OK, check point ④ again.

If ④ is OK, proceed.

- Check point ④ (is RE + 650 Hz).
Value should be V_{pp} if so, proceed.
When the set is in the normal stand-by position 650 Hz at 300 mV is present on point ④.
- To check radial output stage, do not use a disc, only power on. Inject on points ④ and ④ respectively a sine-wave signal of 8 to 10 Hz 3 V_{pp}.
Then the radial motor will go back and forth.

At this moment radial tracking must be possible in service loop 3.

- Switch the AGC circuit on again.

If the original fault symptom is still present proceed

to Annex III:

Check of the k-factor.

- Switch the offset circuit on again.

If the original fault symptom is still present, proceed to Annex II:

Check of the d-factor.

Sub. I. IS $\overline{\text{INT}}$ FUNCTIONING. O.E. POLARITY OF RE?
(Measure points on servo PCB)

Test method

Bring player in service loop 3 and measure $\overline{\text{INT}}$ on pin 12 of μP servo IC Q271.

A square-wave voltage (0-5V) should be measured on this pin. As a result of the frequency variation this square-wave is hard to trigger.

I DECODER-A IC

● Check the MC signal (pin 17; test point ④)

- In stand-by mode, the MC signal (Motor Control) corresponds to the figure below.

Note:

The repetition time of the MC signals is 11.3 μsec .

- Place a disc on the turntable.
- In position PLAY or SERVICE POSITION 3, the MC signal corresponds to the figure below.

Note:

During start-up the duty cycle is 98%, then the duty cycle of the signal becomes about 50%.

See also Service Manual CDM-1: "Check of the motor control".



● Check the HF signal on test point ⑤ (eye pattern)

- Place a disc on the turntable.
- The HF signal should be present and be stable in the PLAY mode and in: SERVICE POSITION 3 after the run-in track has been read.
- In SERVICE POSITION 2 and during reading of the lead-in track the HF signal is not stable.

Position of oscilloscope 0.5 $\mu\text{s}/\text{DIV}$.

Amplitude $\approx 1.5 \text{ V}_{\text{pp}}$



● Check the $\overline{\text{HFLD}}$ signal on test point ⑥

- Place a disc on the turntable.
- In the PLAY mode and in SERVICE POSITION 3 the $\overline{\text{HFLD}}$ signal is "high"; however, minor pulses may be present and in cause of disorders on the disc.
- In SERVICE POSITION 2 and during playback of track no. 15 of test disc 5A $\overline{\text{HFLD}}$ pulses are visible.

Position of the oscilloscope 5 ms/DIV

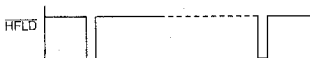

● Check if the $\overline{\text{MUTE}}$ signal (pin 11; test point ⑦) is "high"

When Filter-B IC is applied, the $\overline{\text{MUTE}}$ input will not be used.

● Check the CEFM signal (pin 27; test point ⑧)

- Place a disc on the turntable.
- In stand-by mode (only the main switch is depressed), the frequency lies between 2.82 MHz and 5.64 MHz.
- In the position PLAY and SERVICE POSITIONS 2 and 3, the frequency is 4.32 MHz.

● Check the Xin signal (pin 19; test point ⑨)

- The Xin frequency is 11.2896 MHz.
- If this frequency deviates, check test point 70; Xout signal, on Filter-B IC. This frequency should also be 11.2896 MHz.

● Check the timing signals meant for Filter-B IC

- Place a disc on the turntable.
- Select one of the following positions: SERVICE POSITION 2 or 3, or position PLAY.
- Trigger the oscilloscope with the WSAB signal (test point ⑩, pin 39).
- Check signals:
 - WSAB at test point ⑩ (pin 39) (Word Select from Decoder-A to Filter-B)
 - CLAB at test point ⑪ (pin 38) (Clock from Decoder-A to Filter-B) and their interrelation.
- There must be activity at test point ⑫ (pin 37), DAAB signal (DATA from Decoder-A to Filter-B).

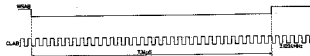

● Check the EFAB signal (Error Flag from Decoder-A to Filter-B) at test point ④ (pin 36)

- Place test disc 5A on the turntable.
- During playback, EFAB pulses should be present at test point ④ for soft braking of the disc and during fast search (F.Forward, F.Reverse).

Note:

Filter-B IC is capable of interpolating linearly 8 successive EFAB pulses.

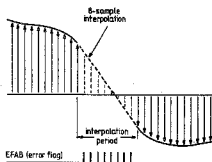

● Check the Q-channel signals

- Place a disc on the turntable.
- Select one of the following positions: SERVICE POSITION 3 or position PLAY.
- Trigger on the QRA signal (Q-channel Request Acknowledge) test point ⑤; pin 30.
- Check signals QRA at test point ⑤ (pin 30).

QCL at test point ⑥ (pin 31).

(Q-channel-clock)

and their interrelation.

- There should then be activity at test point ⑦ (pin 29) QDA (Q-channel Data).

Note:

The QRA request is initiated by decoder μP (QRA "high"). Then Decoder-A answers this request (QRA goes "low"). With the next leading clock pulse (QCL) the QRA signal is rendered "high" again by the decoder μP .

As soon as the decoder μP has taken in enough information via QDA, QRA will go low again. That is why the QRA times vary each time.

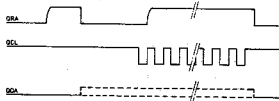

● Check the \overline{SSM} signal (test point ⑧; pin 33) = Start-Stop turntable motor

- Motor start pulse when test point ⑧ is "high" for ≥ 0.2 sec.
- Motor start pulse when test point ⑧ is "low" for ≥ 0.2 sec.

Note:

After the motor start pulse, SWAB information (Subcoding Word clock) will become visible at this point. The period time of that signals is 136 μ sec.

● Check the subcode clock signals

- Place a disc on the turntable.
- Select one of the following positions: SERVICE POSITION 3 or position PLAY.
- Trigger the oscilloscope with the SWAB signal at test point ⑧.

- Check the following signals:

SWAB at test point ⑧; pin 33

SCAB at test point ⑨; pin 35 (Subcode Clock from Decoder-A to Filter B)

SDAB at test point ⑩; pin 34 (Subcode Data from Decoder-A to Filter B)

and their interrelations.

Note:

While the burst of 10 clock pulses, appear on SCAB the Q-channel information is transferred on SDAB. Hereafter the P-bit indication follows.

The P-bit "high" between two bursts of 10 clock pulses in case of pause indication and "low" in case of music indication.

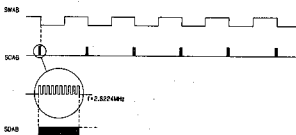

● Check the \overline{CRI} signal

The \overline{CRI} is "low" in case of track jumping. Player in position SEARCH.

II FILTER-B IC

● Check the signals between Decoder-A IC and Filter-B IC

See sub. "I Decoder-A IC".

- Check the X IN signal (test points $\diamond 1$ and $\diamond 2$)
- Check the timing signals meant for Filter B (WSAB, CLAB, DAAB signals; test points $\diamond 7$, $\diamond 8$ and $\diamond 9$)
- Check the EFAB signal (test point $\diamond 3$)
- Check the subcode clock signals (SWAB, SCAB, SDAB signals; test points $\diamond 5$, $\diamond 6$ and $\diamond 4$).

● Check the DOBM signal (Digital Output)

- Place a disc on the turntable.
- Select the stand-by mode (only mains switch depressed).
- Trigger the oscilloscope with the SWAB signal (test point $\diamond 4$).
- Check the DOBM signal (test point $\diamond 9$; pin 14). An empty audio signal has a fixed pattern. See drawing, "Stand-by".
- Select the PLAY mode. Check the DOBM signal. See drawing "PLAY".

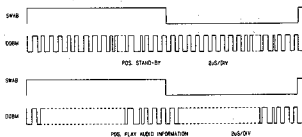

● In position SEARCH the $\overline{ATS\bar{B}}$ signal is "low" test point $\diamond 9$; pin 22 (Attenuation Audio Signal)

- When the μP panel is applied, (a sub-printed circuit board) that houses IC Q271, test point $\diamond 9$ is not connected.

● Check the $\overline{MUS\bar{B}}$ signal test point $\diamond 9$; pin 23 (Soft Mute)

This signal is "low" in positions:

- PAUSE
- NEXT or PREVIOUS when jumping from one track to another.
- Fast SEARCH when the Search button is kept depressed for some time.

VI FAVOURITE TRACK SELECT (FTS)

Attention:

When repairing a CD player it is important that the contents of the FTS memory (EEPROM) should not unnecessarily be damaged.

If no complaints are reported about the functioning of the FTS, a check of the functions of the EEPROM should be left undone.

The EEPROM IC is in the Stand-by mode when \overline{CE} and RDY are both high.

Selftest of the FTS μP

During the self-test of the FTS μP , I/O Gate will not be tested.

Therefore this self-test can be executed without damage to the memory as indicated in General Test Points.

Annex I: LASER IS GIVING NO OR INSUFFICIENT LIGHT

Together with laser supply and the monitor diode the laser forms a feedback system.

A defect in the laser supply might thus result in destruction of the laser. Replacement of the laser (=new light pin) will not solve anything. The new laser will also be destroyed since the original fault in the laser supply is still present.

On the other hand it is impossible to check and repair a feedback system when one link is missing.

For this reason the so-called laser simulator, 3 is supplied. Code number 4822 395 30229.

This laser simulator consists of a PCB which contains the laser and monitor simulation, a switch to test the On/Off position and a number of sockets.

This PCB can be connected to the laser supply instead of the light pin so that the feedback system is closed.

Repair procedure:

Since the light pin is very sensitive to static charges, care should be taken that during measurements and adjustments of the laser power supply the potential of the aids and yourself equal the potential of the CD mechanism.

Detach light pin and connect laser simulator as follows: (connections on pre-amp PCB).

Take the flex PCB out of socket 11 and connect the simulator PCB with the socket.

Remove plug 16 and insert it in the socket on the simulator PCB.

Connect the plug with 4 wires to socket 16. Take out plug 17 and insert the plug with 1 wire in socket 17.

- Switch on the mains switch and ensure that the drawer is closed or else that the tray-end-in switch on the tray PCB (S004) is depressed. Now press the play key and check if the L-line of the servo μP , pin 2-1 on the pre-amplifier PCB, goes "low".

- In rest position the current through the laser diode should be $\leq 1 \text{ mA}$. For NEG. VOLT. lasers this can be checked as follows:

Set the switch on the simulator PCB in the OFF position and the mains switch in the ON position. Turn trimming resistor 3180 counterclockwise (min. R) and measure the voltage across resistor 3194 on the pre-amp. PCB.

On pre-amplifier PCBs with discrete components turn resistor 3180 clockwise (min. R) and measure the voltage across resistor 3194. The voltage should be $\leq 15 \text{ V}$.

Check of laser supply control

Set the switch on the simulator PCB in the ON position and measure the voltages between points +V and =V on the simulator PCB.

Resistor 3180 clockwise (max. R): $U_{+V-V} = 225 \text{ mV} \pm 45 \text{ mV}$. On pre-amplifier PCBs with discrete components resistor 3180 counterclockwise (max. R): $U_{+V-V} = 225 \text{ mV} \pm 45 \text{ mV}$.

R3180 counterclockwise (min. R): $U_{+V-V} = 750 \text{ mV} \pm 150 \text{ mV}$.

On preamplifier PCBs with discrete components resistor 3180 clockwise (min. R): $U_{+V-V} = 750 \text{ mV} \pm 150 \text{ mV}$.

Set resistor 3180 in the mid-position.

This is a preliminary adjustment. After the simulator PCB has been removed the laser current must be adjusted.

Fine adjustment of laser current

- Playback track 1 of test disc 4822 397 30096 (Disc without defects). Connect a DC voltmeter across resistor 3308 on the SERVO PCB circuit diagram D. Adjust the laser power supply with resistor 3308 is $575 \text{ mV} \pm 50 \text{ mV}$.

Annex II: CHECKING d-FACTOR

(Test points on servo PCB)

- Switch off AGC circuit (k-multiplier) and switch off offset circuit (d-multiplier). See sub G and H.

Place disc on turntable and set player in service loop 2.

- Check points $\diamond 2$ and $\diamond 3$. Value should be $0.7 V_{pp}$. Frequency variation strongly depends on the eccentricity of the disc.

- Check points $\diamond 4$ and $\diamond 5$. Value should be 250 mV_{pp} .

- Check point $\diamond 6$. Value should be 200 mV_{pp} .

- Check point $\diamond 7$. Value should be $2 V_{pp}$.

- Check points $\diamond 8$ and $\diamond 9$. Value should be $10 V_{pp}$.

The signals is more sine-shaped now due to filtering out of 650 Hz.

- Point $\diamond 10$ is hard to measure since switch is in position Yoc and thus connected with input of op-amp Q302 (pin 9).

However, a signal of 200 mV_{pp} is present.

- Check point $\diamond 11$. Value should be $9 V_{pp}$.

Bring the player in service loop 3. With a disc on turntable and the AGC and offset-circuits are still switched off.

- Check point $\diamond 12$.

- Check point $\diamond 13$ on beam A of oscilloscope and check point $\diamond 14$ on beam B of oscilloscope while oscilloscope is triggered with point $\diamond 15$.

- Switch on the AGC-circuit and offset circuit.

Annex III: CHECKING k-FACTOR

(Test points on Servo PCB)

a. Static

Switch power on **without** depressing the Play button. i.e. RC0=high; RC0=low so switch Ya is in position 0 and switch Yc is in position 0.

- Check point $\diamond 16$. Value should be $9 V_{pp}$.

- Check point $\diamond 17$. On point $\diamond 18$ now appears a sine-wave signal of 650 Hz, 300 mV , and $180-45=360^\circ$ shifted in phase relative to signal on point $\diamond 19$.

- Check point $\diamond 20$. Value should be $1.5 V_{pp}$.

- Check point $\diamond 21$. Value should be $1 V_{pp}$.

- Check points $\diamond 22$, $\diamond 23$, $\diamond 24$ and $\diamond 25$ relative to each other.

Amplitudes are 5V.

- Check Itegrator IC Q303 (4/4)

b. Dynamic

Insert disc, select service loop 2 and check if the signal on point ④ equals to $7 V_{pp}$.

— Select service loop 3.

Now $RC0$ =high and $RC1$ =low.

So switch Y_a is in position 1.

Switch Y_c switches at $f=650$ Hz.

Point ④ is low; so point ⑤ is in phase point ⑥.

Now fig. U should be present on point ⑤ with duty cycle jittering round 50%.

Annex IV: CHECKING RF PRE-AMPLIFIER

(measure points on pre-amp. PCB)

- a. Check DC-voltages on transistor 6103, 6104, 6105, 6109, 6110, 6111.

- b. For checking sensitivity, frequency and delay characteristic, proceed as follows:
 - Take flex PCBs of sockets 10 and 11.
 - Take plugs 18, 17, 12, 13, 14 and 15 out of sockets.

SERVO

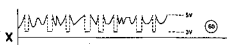
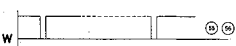
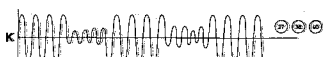
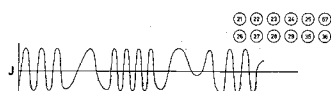
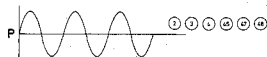
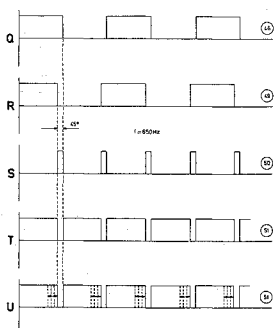
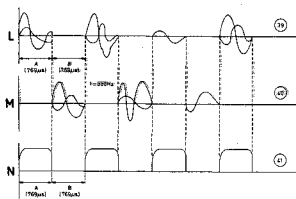
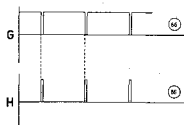
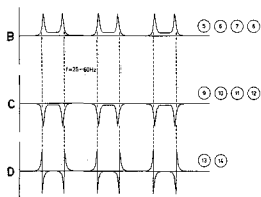

SERVO

Nr.	See	Position	Amplitude	f	Time base
1		see fault finding meth.			
2	P	see fault finding meth.	0,6 Vp-p	10 Hz	
3	P	see fault finding meth.	6 Vp-p	10 Hz	
4	P	see fault finding meth.	5 Vp-p	10 Hz	
5	B	see fault finding meth.	40-80 mV	25-60 Hz	
6	B	see fault finding meth.	40-80 mV	25-60 Hz	
7	B	see fault finding meth.	40-80 mV	25-60 Hz	
8	B	see fault finding meth.	40-80 mV	25-60 Hz	
9	C	see fault finding meth.	-2 V	25-60 Hz	
10	C	see fault finding meth.	-2 V	25-60 Hz	
11	C	see fault finding meth.	-2 V	25-60 Hz	
12	C	see fault finding meth.	-2 V	25-60 Hz	
13	D	see fault finding meth.	-8 V, +8 V	25-60 Hz	
14	D	see fault finding meth.	depends on R3158	25-60 Hz	
15		see fault finding meth.			
20		see fault finding meth.			
21	J	see fault finding meth.	12-14 Vp-p		
22	J	see fault finding meth.	0,7 Vp-p		
23	J	see fault finding meth.	0,7 Vp-p		
24	J	see fault finding meth.	0,2 Vp-p		
25	J	see fault finding meth.	0,25 Vp-p		
26	J	see fault finding meth.	20 mVp-p		
27	J	see fault finding meth.	800 mVp-p		
28	J	see fault finding meth.	800 mVp-p		
29	J	see fault finding meth.	6 Vp-p		
29	P	ON	0,3 Vp-p		
30		see fault finding meth.			
31		see fault finding meth.			
32	.	see fault finding meth.			
33	.	see fault finding meth.			
35	J	see fault finding meth.	200 mVp-p		
36	J	see fault finding meth.	2 Vp-p		
37	K	see fault finding meth.	10 Vp-p		
38	K	see fault finding meth.	10 Vp-p		
39	L	see fault finding meth.	0-4 Vp-p		A = 769 μ s B = 769 μ s
40	K	see fault finding meth.	9 Vp-p		A = 769 μ s B = 769 μ s
40	M	see fault finding meth.	0-4 Vp-p		A = 769 μ s B = 769 μ s
41	N	see fault finding meth.	6 Vp-p		A = 769 μ s B = 769 μ s
45	P	ON	9 Vp-p	650 Hz	
46	Q	ON	0-5 V	650 Hz	A = 769 μ s B = 769 μ s
47	P	ON	1,5 Vp-p	650 Hz	
48	P	ON	1 Vp-p	650 Hz	
49	R	ON	0-5 V	650 Hz	
50	S	ON	0-5 V	650 Hz	
51	T	ON	5-0 V	650 Hz	
51	U	service loop B	5 V	650 Hz	
52		see fault finding meth.			
55	Y	service loop A	5-0 V		
55	W	play (with test disc)	5-0 V		
56	W	play (with test disc)	5-0 V		
57		see fault finding meth.			
60	X	service loop A	5-3 V		
61	Y	service loop A	5-0 V		
62	Y	service loop A	5-0 V		
65	A	play	1 Vp-p		
66	G	see fault finding meth.	5-0 V		
66	H	see fault finding meth.	0-5 V		
67	J	see fault finding meth.			

BLOCK DIAGRAM WARDS INFOMATION

DAC0 - DAC3	Control bit for radial circuit	<u>SSM</u>	Motor Start-Stop signal
DAC	Current output for track jumping	<u>MUTE</u>	Mute signal
<u>DO</u>	Drop out detector signal	<u>MUSB</u>	Soft Mute signal
D1 - 4	Photodiode Currents	PD/OC	Phase detector-oscillator control
FE	Focus error signal	QCL	Q-channel Clock signal
HF	HF output for DEMOD	ODA	Q-channel Data signal
<u>HFLD</u>	HF detector output for DEMOD	QRA	Q-channel Request Acknowledge
MSC	Motor control signal	SCAB	Subcode clock Decoder-A to Filter-B
RE	Radial error signal (Amplified RE2 - RE1 currents)	SDAB	Subcode data Decoder-A to Filter-B
RE1	Radial error signal 1 (Summation of amplified currents D3 and D4)	SWAB/ <u>SSM</u>	Subcode Word/Start-Stop Motor signal
RE2	Radial error signal 2 (Summation of amplified currents D1 and D2)	WSAB	Word select Decoder-A to Filter-B
<u>TL/INT</u>	Track loss signal	WSBD	Word select Filter-B to DAC
Vc	Control voltage for turntable motor	XIN	Oscillator signal in Decoder-A
<u>ATSB</u>	Attenuation of Audio level in search position (cuesing)	XSYS	Oscillator signal OUT Filter-B
CEFM	Clock 4.3218 MHz	RDIR	Radial current switch control signal Normal, or Revers
CLAB	Clock signal Decoder-A to Filter-B	RP	Radial puls after Track Jump
CLBD	Clock signal Filter-B to DAC	FN	Focus Neutral
CRI	Counter Reset Inhibit	ANIN	
DAAB	Data signal Decoder-A to Filter-B	<u>HFLS</u>	HF Loss signal
DABD	Data signal Filter-B to DAC	<u>SRDO</u>	Signal Radial ON/OFF for Track jump
<u>DEEM</u>	Deemphasis ON-OFF signal	RCO	Switch Digital to Analogue
DOBM	Digital out signal	FC1, FC2	Focus UP/DOWN signal
EFAB	Error flag Decoder-A to Filter-B	<u>FCO</u>	Focus ON/OFF signal
IREF	Reference current	L	Laser ON/OFF signal
		BUSY	μ -COM Communication Clock
		RXD	μ -COM Communication Receive Data
		TXD	μ -COM Communication Telex Data

Loading Tray Mechanism

Cautions When Servicing

1. Installation of Tray and Tray Case

(Upon replacement of the tray case due to breakage, etc.)

- ① If the position with respect to the tray's front panel window is incorrect, loosen screws (A) and move the tray within the range of play of the hole to adjust. For the inclination of the tray, refer to diagram below.

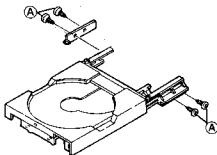

The tray should not be more than 0.4 mm above the rollers on the bottom side.

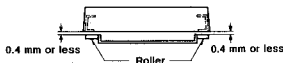

Adjust the inclination as well with screws (A).

- ② The tray's working force should be set to between 200 and 400 gr (when power is off).

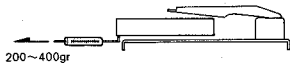

2. If Tray has become detached downward

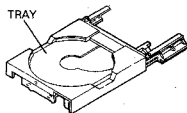

Take care in the following instances as the tray will become detached downward.

- The tray will become detached if pressed downward when there is no subchassis (CDM-1). (The same is true when the tray is closed with no subchassis.)

Use the following procedure to reinstall.

- ① Lower the lever and place the tray on the projection.

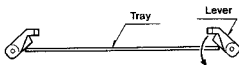

- ② Next, with the tray pressed down, lower the other lever and place the tray on its projection.



NOTE:

Be sure to lower only one lever at a time as the tray cannot be lifted if they are both lowered.

NOTE:

If the tray is forced back to its original position, the two pins in the tray case may bend.

3. If Subchassis (CDM-1) has been replaced

- ① The height of the subchassis turntable differs from one unit to the next, so it is necessary to adjust according to the height of the turntable so that the magnet clamber is not in contact with the clamber fitting. (Standard 2 ± 0.3 mm)

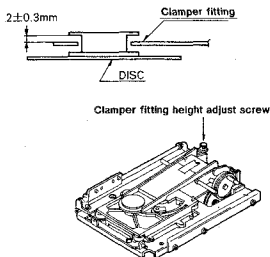

- ② When the height of the clamber fitting is adjusted, the position when the clamber is up must be readjusted. Use the following procedure.

Disc clamber position

When up Max. 43 mm
(Tray and clamber should not come into contact when tray is opened and closed.)

To the eye, this fitting appears parallel to the chassis.

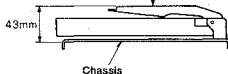

Clamber up position adjust screw

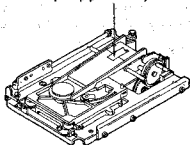

4. Others

- ① Refer to the diagram below to install the loading wire.

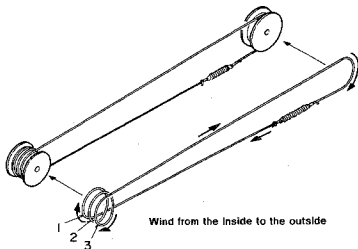

- ② All switches on the mechanism are of the socket type. If a switch breaks, remove the socket to replace.
- ③ Use to the structure of the hooks of the magnet clamber (094M), incline as indicated below to remove and install the magnet clamber when replacing it.



The narrowest hook inclines

- ④ When the tray is disassembled, take care of the up/down and front/rear directions of the POWER SW button and aluminum panels of the tray.

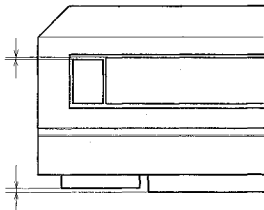

3. Twin PLL with memory method

PLL has reciprocal characteristics that low-speed (narrow-band) is preferable in the view of sound quality and high-speed (broad-band) is better in the view of decoder responsibility. Thus, we set two lines of PLL, high-speed and low-speed types. Clock with much jitter made by high-speed PLL (1st PLL) controls decoder, and clock with less jitter made by low-speed PLL (2nd PLL) controls digital filter and DAC, easily influenced by sound quality (clock for DAC is not supplied directly from low-speed PLL but through digital filter).

The method for making jitter margin high is:

- to position word memory which consists of 16 bit shift register before digital filter,
- store once the data with jitter from decoder in the memory,
- at the time that the data was stored for 1 word (16 bit), read out with less-jitter clock made by low-speed 2nd PLL to send to digital filter.

That is, jitter in data is to be cut by storing once the data in memory per word.

4. Circuits motion

1) Preamble detector (Q463-1/4 - 4/4, Q464-1/2, 2/2)
Detect head signal per sample of 16 bit data to output to phase comparator (Q465) as a synchronizing signals. The frequency is 88.2 kHz at 44.1 kHz sampling.

2) Second PLL (low speed)

It consists of:

- Phase comparator (Q465)
- Low pass filter for band-pass restriction (Q455, Q456)
- VCO (Q457) which changes oscillation frequency by voltage output of L.P.F.
- Frequency divider (Q465-2/1, 2/2) which works (1/128 freq. division) with duty ratio of 50% accurately.

The basic operation is:

- First VCO starts oscillation with free-run frequency set up in advance.
- Then phase comparator with work to compare phase of signal divided by freq. divider and phase of synchronizing signal of received data.
- Voltage corresponding to the phase difference is made out, which will be fed back through L.P.F. to VCO, to change the oscillation frequency in order to reduce the phase difference.
- Then soon it will be locked at the point where the frequency of freq. divided signal and the phase are almost equal.
- Master clock (11.2896 MHz) synchronizing with received data will output VCO output to digital filter via AND gate IC (Q473 4/4).

7. CD-12 PARTS LOCATIONS(Pattern Side)

PM16-FEATURE μ -COM

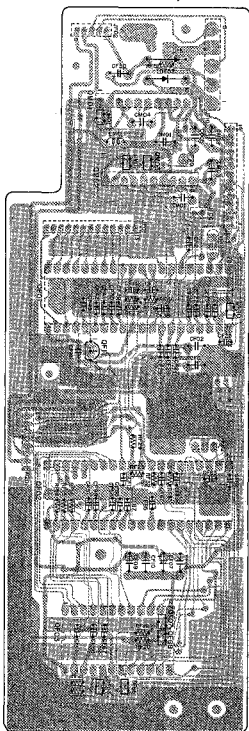

PY16-DISPLAY

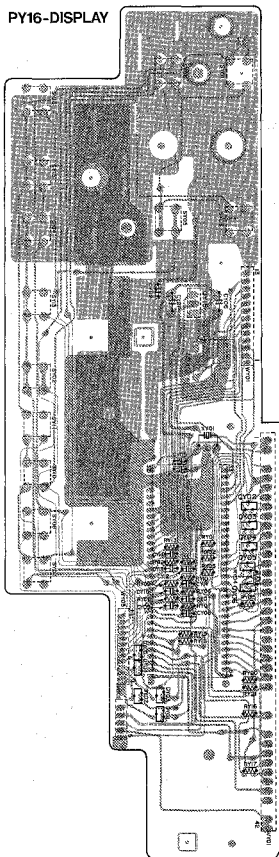

PV26-SERVO MODULE

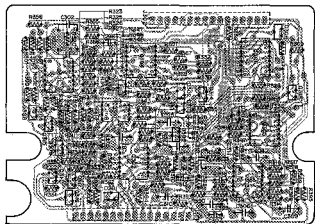

2. Digital signal error muting

In the event of digital signal error, potential is discharged at point B and the muting time of approx. 1.5 ms is provided by R809 and C812.

3. Input selector switching muting

1. The selector switches are of the non-shorting type. DS07 and DS08 are combined to generate a High

pulse at the instant one of the switches is selected. This signal, S MUTE, is applied to Q478 (monostable multivibrator) which generates a muting pulse of approx. 700 ms. The muting pulse performs digital muting by cutting off CLOCK at pin 11 XTAL IN of JB (Q407) in the end. On the other hand, audio muting is also performed in the same way, but the operation speed is slower with audio muting.

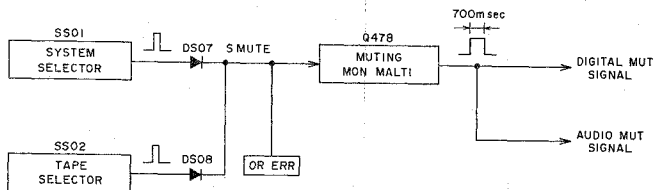

2. The timing chart is as shown below.

The difference between the digital muting time and analogue muting time, which is 800 ms, is a marginal

time for preventing noise due to unstable data output at the moment of rise of the PLL.

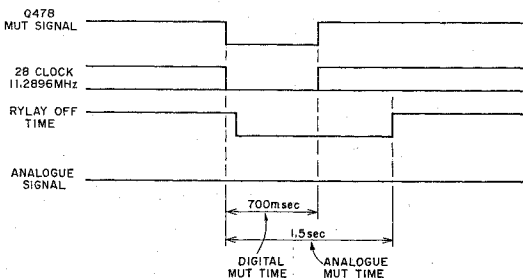

JITTER KILLER CIRCUIT

Jitter (sway or lag of time axis, a kind of error) which occurs in optical transmission line.

The circuit method is "memory twin PLL" method. This circuit is especially effective for improving distortion rate in high frequency band.

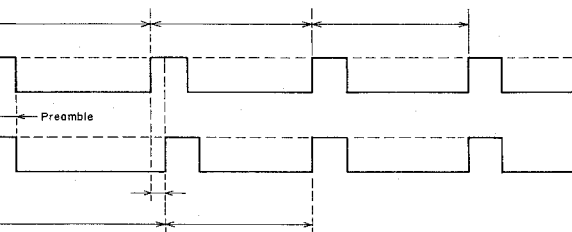

Jitter killer circuit diagram

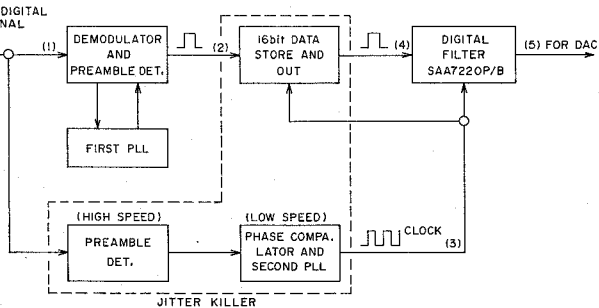

6. DA-12

ANALOGUE MUTING

1. Power ON/OFF muting

When the power is switched ON, the collector of Q807 outputs the muting pulse for approx. 1.5 s according to the time constant of C811 and R807. Q808 then generates the inverted pulse, which cuts off Q809 and

Q810 to turn the muting relay OFF. When the power is switched OFF, the Muting-On time of approx. 60 ms is delayed by R805 and C810. This is performed by delaying the relay operation by 60 ms which corresponds to the lack of 3 cycles in 50 Hz frequency. However, the audio operation is normal during this period because the discharge characteristics of the audio and other circuitry are longer than the time constant.

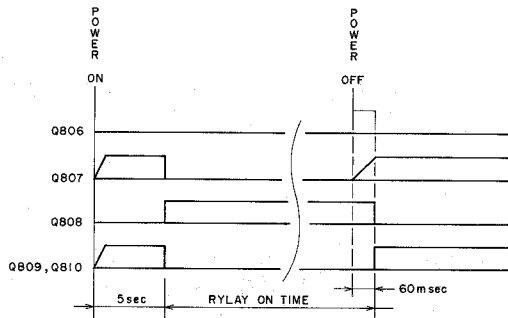
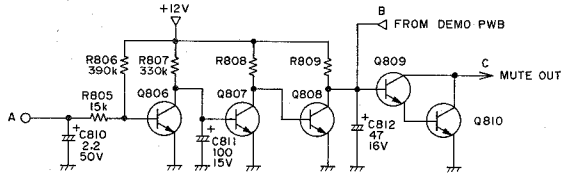

2. Digital signal error muting

In the event of digital signal error, potential is discharged at point B and the muting time of approx. 1.5 ms is provided by R809 and C812.

3. Input selector switching muting

1. The selector switches are of the non-shorting type. DS07 and DS08 are combined to generate a High

pulse at the instant one of the switches is selected. This signal, S MUTE, is applied to Q478 (monostable multivibrator) which generates a muting pulse of approx. 700 ms. The muting pulse performs digital muting by cutting off CLOCK at pin 11 XTAL IN of IB (Q407) in the end. On the other hand, audio muting is also performed in the same way, but the operation speed is slower with audio muting.

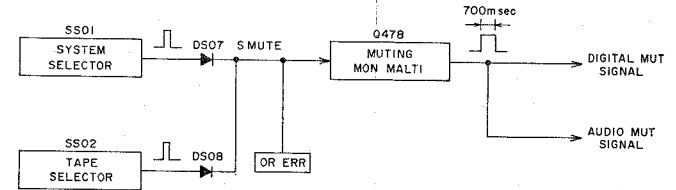

2. The timing chart is as shown below.

The difference between the digital muting time and analogue muting time, which is 800 ms, is a marginal

time for preventing noise due to unstable data output at the moment of rise of the PLL.

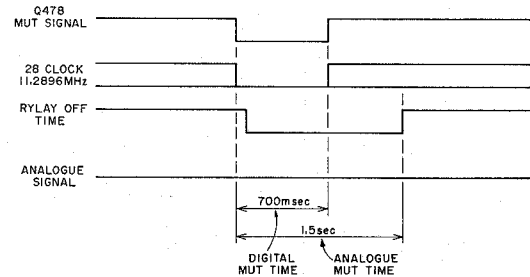

INPUT/TAPE MONITOR CHANGEOVER

1. The input selectors generate signals A and B respectively with the diode matrices. These signals are used for the control of IC Q301 and Q318.

- a. The inputs to Q318 at pins 10, 11, 12 and 13 are selected according to the control signal Inputs A1 and B1, and one of D0 to D3 is output at Yb (pin 9).
 b. Q301 switches the TAPE MONITOR signal with the same logic as above.

SS01

POSSION	A ₁	B ₁	OUT (9 PIN)
1	L	H	D ₁
2	L	L	D ₀
3	H	L	D ₂
4	H	H	D ₃

SS02

POSSION	A ₂	B ₂	OUT (9 PIN)
1	L	H	D ₁
2	H	H	D ₃
3	H	L	D ₂
—			

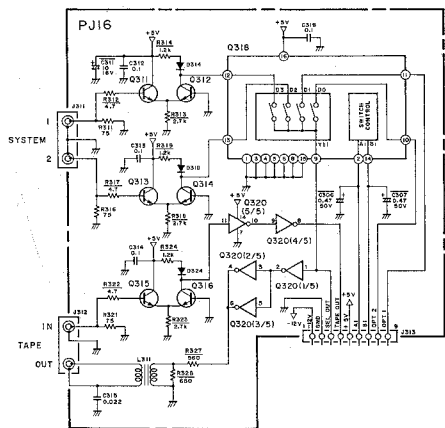

JITTER KILLER CIRCUIT

It is to kill jitter (sway or lag of time axis, a kind of distortion) which occur in optical transmission line.

The circuit method is "memory twin PLL" method. This circuit is especially effective for improving distortion rate in high frequency band.

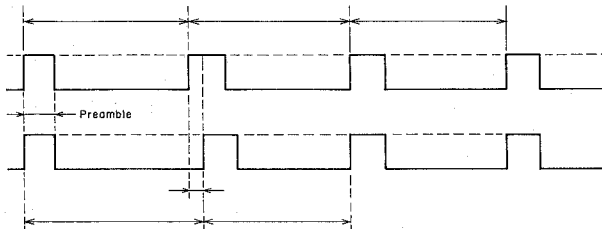

2. Jitter killer circuit diagram

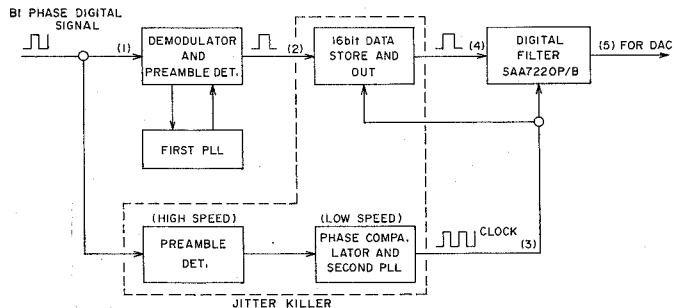

PD16-POWER/DEMO

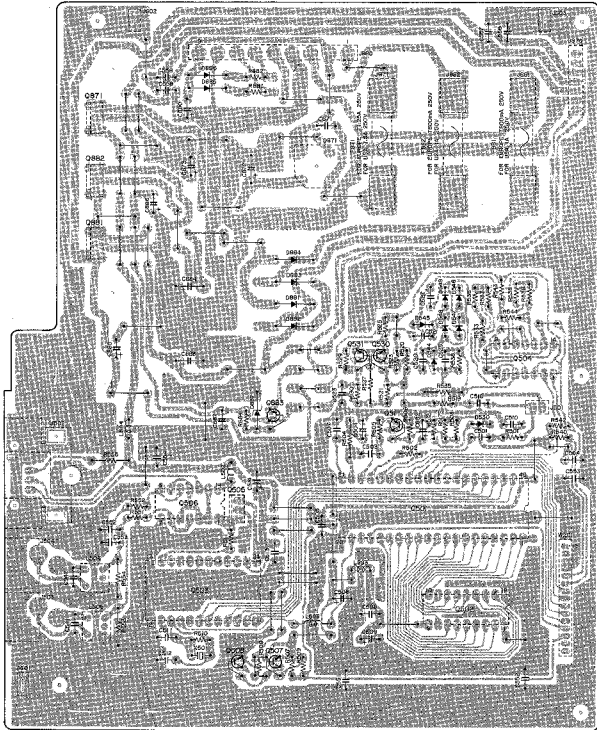

PV16-SERVO

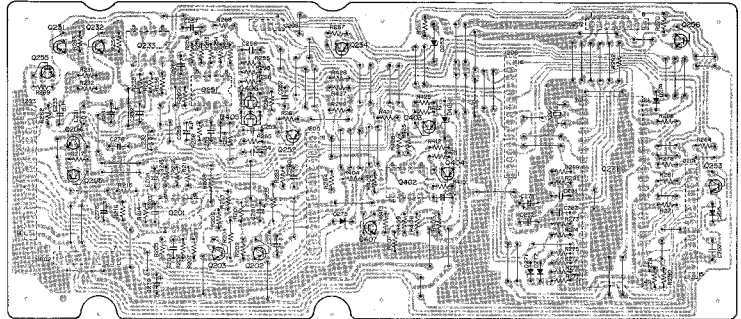

PS26-TEN KEYS

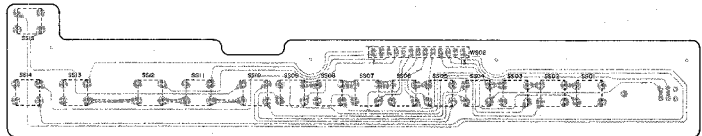

PP46-POWER SWITCH

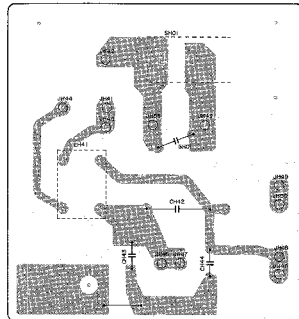

8. DA-12 PARTS LOCATIONS(Pattern Side)

PA16-AUDIO/DAC

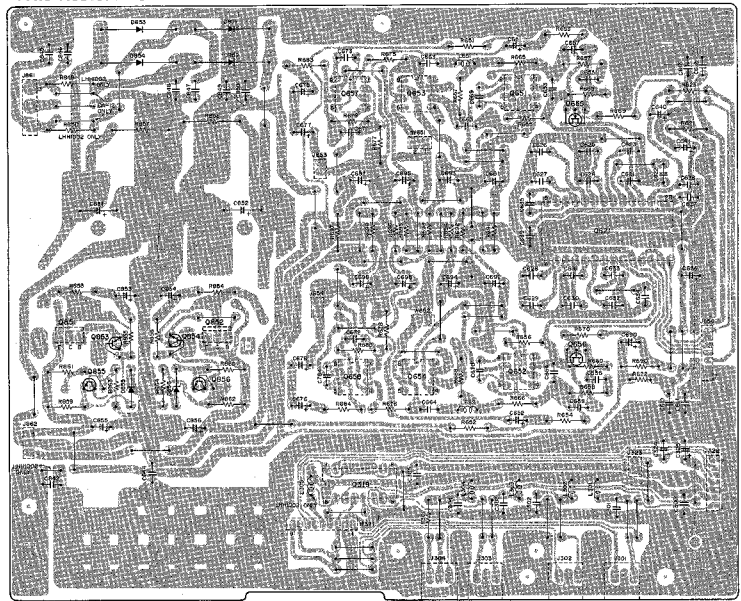

PP16-POWER SUPPLY

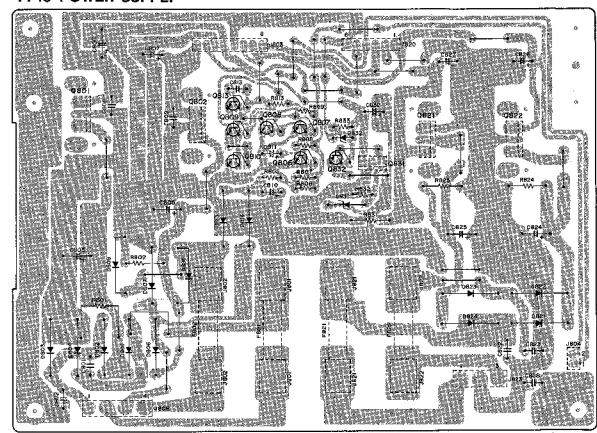

PD16-DEMO

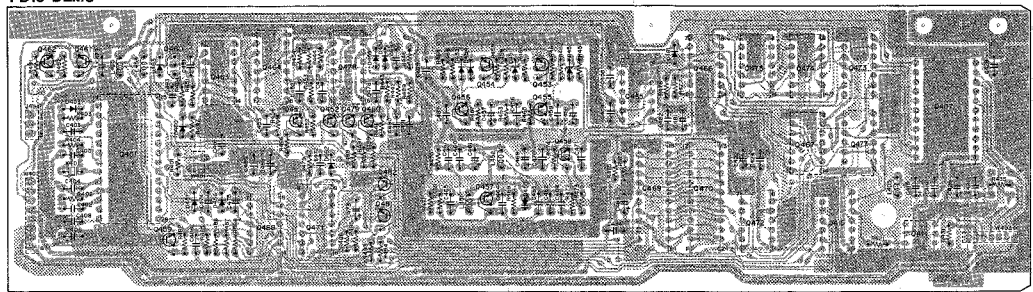

PA26-BALANCE AMP

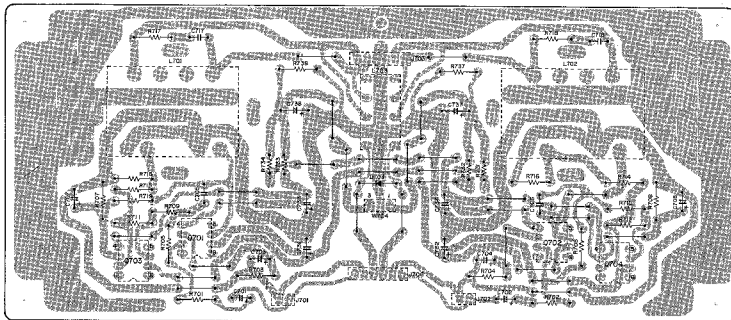

PJ16-DIGITAL IN/OUT JACK

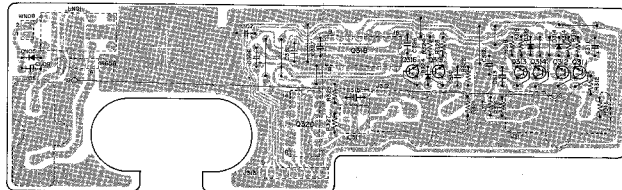

PP26-POWER SWITCH

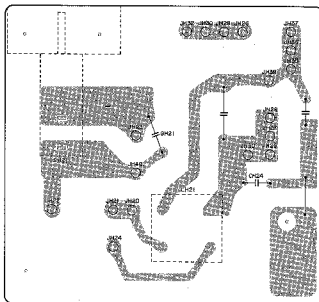

PL16-LAMP

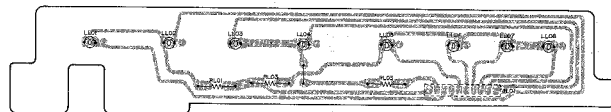

PS16-FUNCTION SWITCH/PHONE

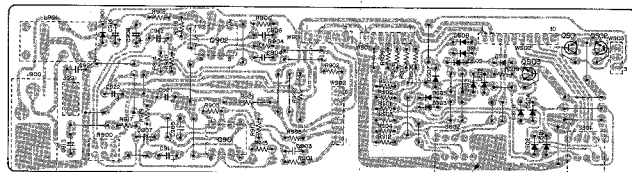

9. RC-12CD PARTS LOCATIONS(Pattern Side)

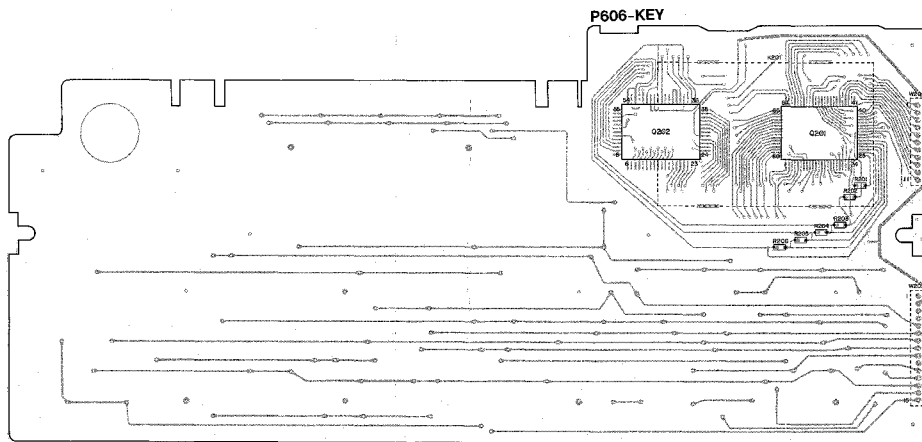
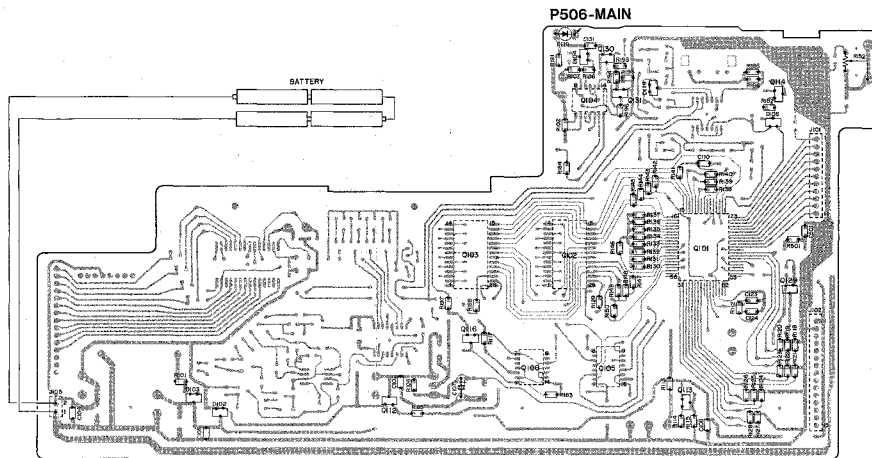

10. CD-12 EXPLODED VIEW AND PARTS LIST

Model CD-12

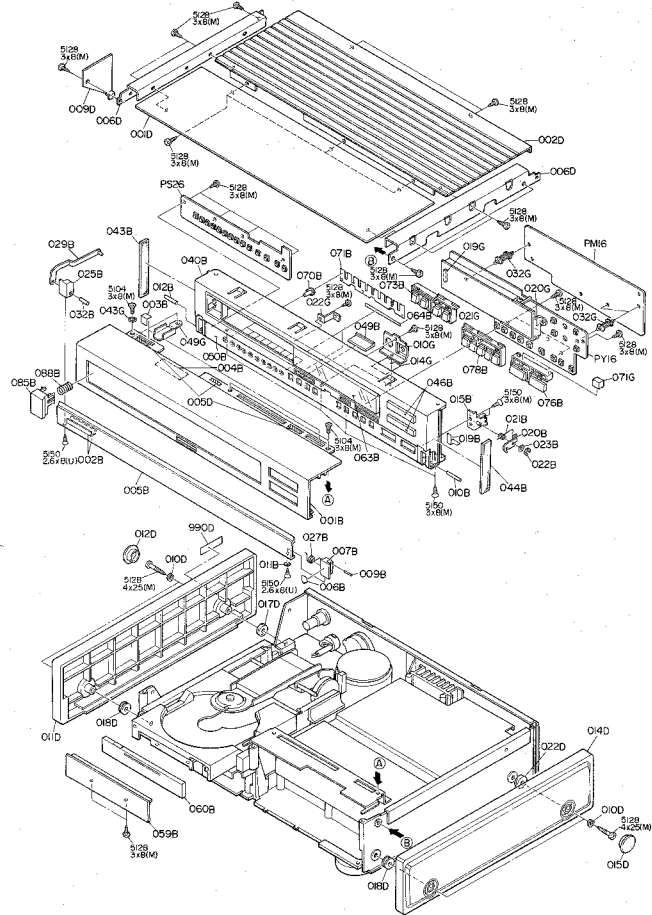

REF. DESIG.	PART NO.	DESCRIPTION	
002B	4822 459 10855	Badge	
003B	4822 532 52078	Spacer	
007B	4822 417 11032	Hinges (R)	
008B	4822 536 92367	Shaft, Lock	
010B	4822 535 92368	Shaft, Hinge (R)	
012B	4822 535 92368	Shaft, Hinge (L)	
015B	4822 402 61225	Bracket (K), Lock Hook	
020B	4822 402 61096	Hook, Lock	
021B	4822 492 42111	Spring, Lock	
022B	4822 532 11301	RG Ring, E Type	φ2.5
023B	4822 532 52081	Washer	
029B	4822 417 11033	Hinge (L)	
027B	4822 492 42112	Spring, Open	
029E	4822 402 50243	Joint	
032B	4822 535 92369	Shaft	
060B	4822 460 20758	Eclaircheon, Drower	
063B	4822 450 61315	Window	
070B	4822 410 28992	Button, 10 Key	
071B	4822 492 63757	Leaf Spring, Earth	
073B	4822 410 25896	Button, Sel/Cancel	
076B	4822 410 26884	Button, FF/REV	
078B	4822 410 25885	Button, FTS/Pause	
088B	4822 492 51927	Spring, Power SW.	
001D	4822 444 50615	Lid, Top Cover; Front	
002D	4822 444 30412	Lid, Top Cover; Rear	
005D	4822 462 41094	Buffer	
010D	4822 530 70385	Spring Washer	
011D	4822 444 40285	Side Panel (L)	
012D	4822 444 60607	Cap (L)	
014D	4822 444 40285	Side Panel (R)	
015D	4822 444 60607	Cap (R)	
017D	4822 462 71578	Buffer	
018D	4822 532 52077	Collar (K)	
022D	4822 462 71578	Buffer	
071G	4822 459 20945	Mask, FL	
043G	4822 530 80311	RG Ring, CS Type	φ3
071G	4822 462 41011	Buffer	

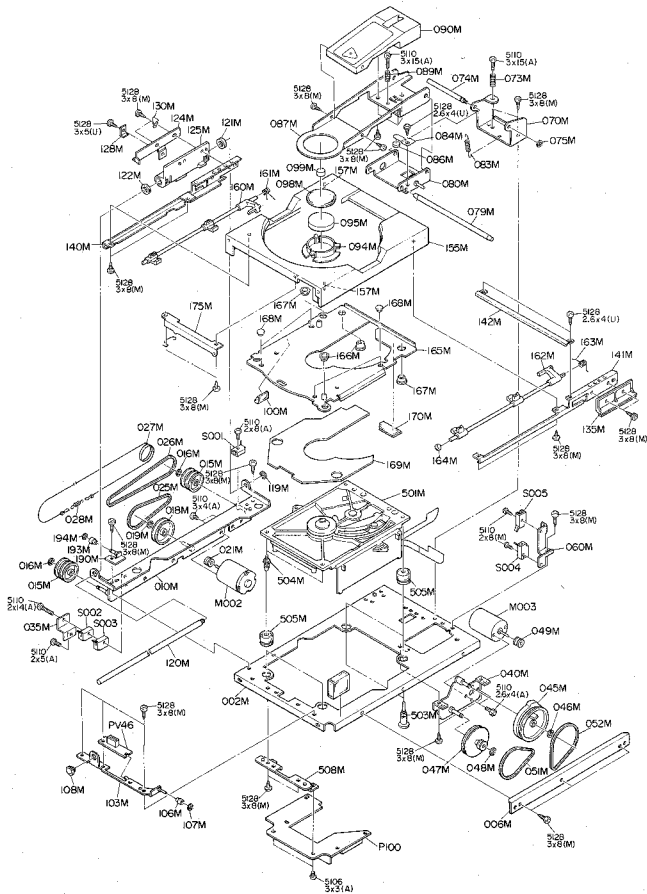

REF. DESIG.	PART NO.	DESCRIPTION
015M	4822 528 81163	Pulley, Wire
018M	4822 532 11301	RG Ring, E Type
019M	4822 528 81238	Pulley, Tray Drive
019M	4822 532 11301	RG Ring, E Type
021M	4822 528 81186	Pulley, Motor
025M	4822 358 30762	Belt, Motor
026M	4822 358 30903	Belt, Tray Drive
027M	4822 321 30338	Joint, Wire
028M	4822 492 32719	Spring
040M	4822 402 61228	Bracket (K), Motor
045M	4822 528 30331	Cam, Clamper Drive
046M	4822 532 11301	RG Ring, E Type
047M	4822 528 81164	Pulley, Clamper Drive
048M	4822 532 11301	RG Ring, E Type
049M	4822 528 81166	Pulley, Motor
051M	4822 358 30762	Belt, Motor
052M	4822 358 30763	Belt, Cam Drive
073M	4822 492 63706	Spring
074M	4822 538 92332	Shaft
075M	4822 532 11301	RG Ring, E Type
079M	4822 536 92576	Shaft
083M	4822 492 63706	Spring
084M	4822 492 63709	Leaf Spring
086M	4822 466 61549	Buffer
087M	4822 402 30161	Lever, Clamper
089M	4822 492 63706	Spring
090M	4822 256 91378	Holder
094M	4822 402 61097	Clamper
106M	4822 528 90645	Roller
107M	4822 530 70119	RG Ring, E Type
108M	4822 532 21323	Bushing
118M	4822 530 80307	RG Ring, E Type
120M	4822 536 92331	Shaft, Tray Guide
121M	4822 466 61549	Buffer
122M	4822 462 71676	Buffer
160M	4822 402 61089	Lever, Tray Lift (L)
161M	4822 492 63707	Spring
162M	4822 402 61281	Lever, Tray Lift (R)
163M	4822 492 63708	Spring
164M	4822 532 11432	Washer
166M	4822 532 11697	Bushing, Tray Guide
167M	4822 532 21323	Bushing, Tray Guide
168M	4822 532 11698	Bushing, Disc Buffer
193M	4822 528 90645	Roller
194M	4822 530 70119	RG Ring, E Type
501M	4822 691 30221	Mechanism Assembly, CDM-1
503M	4822 536 92574	Shaft
504M	4822 536 92577	Shaft
505M	4822 532 52076	Bushing
M002	4822 361 60467	D.C. Motor, Tray Drive
M003	4822 361 60447	D.C. Motor, Clamper Drive
S001	4822 277 21132	Slide Switch, Tray IN
S002	4822 277 21132	Slide Switch, Tray OUT
S003	4822 277 21132	Slide Switch, Push IN
S004	4822 277 21132	Slide Switch, Clamper Down
S005	4822 277 21132	Slide Switch, Clamper Up

11. CD-12 ELECTRICAL PARTS LIST

ASSIGNMENT OF COMMON PARTS CODES.

- RESISTOR**
R11: (1) GD05 ~ 140, Carbon film fixed resistor, ±5%, 1/4W
R12: (2) GD05 ~ 160, Carbon film fixed resistor, ±5%, 1/4W
 (1) — Resistance value

- Examples**
 (1) Resistance value
 0.1Ω, .001 10Ω, .100 1kΩ, .102 100kΩ, .104 0.5Ω, .005 18Ω, .180 2.7kΩ, .272 680kΩ, .684 1Ω, .010 100Ω, 101 10kΩ, .103 1MkΩ, .105 6.8Ω, .008 390Ω, .391 22kΩ, .223 4.7kΩ, .475
- (Note) Please distinguish 1/4W from 1/8W by the shape of parts used actually.

- C11: CERAMIC CAP**
 (1) DD1 ~ 370, Ceramic condenser
 Disc type
 Temp. coeff. P350 ~ N1000, 50V
- Capacity value
 Tolerance

- Examples**
 (1) Tolerance (Capacity deviation)
 ±0.25% 0
 ±0.5% ~ 1
 ±5% ~ 5
 * Tolerance of COMMON PARTS handled here are as follows:
 0.5pF ~ 5pF ... ±0.25pF
 6pF ~ 10pF ... ±0.5pF
 12pF ~ 500pF ... ±5%
- (2) Capacity value
 ΔD649 0.5pF, .005 3pF, .030 100pF, .101 1pF, .010 10pF, .100 220pF, .221 1.5pF, .015 47pF, .470 560pF, .561

- C11: CERAMIC CAP**
 (1) DK10 ~ 300, High dielectric constant ceramic condenser
 Disc type
 Temp. chara. 2B4, 50V
- Capacity value

- Example**
 (1) Capacity value
 100pF, .101 1000pF, .102 10000pF, .103 470pF, .471 2200pF, .222
- C11: ELECTROLYTIC CAP** (± 1 FILM CAP (± 1)
 (1) EA ~ 100, Electrolytic condenser
 One-way lead type, Tolerance ±20%
- Dielectric strength
 Capacity value

- Examples**
 (1) Capacity value
 0.1μF, .104 4.7μF, .475 100μF, .107 0.35μF, .334 10μF, .108 330μF, .337 1μF, .105 22μF, .228 1100μF, .108 2200μF, .228
- (2) Working voltage
 6.3V, .006 25V, .025 10V, .010 35V, .035 16V, .016 50V, .050
- (2) DF15 ~ 350, Plastic film condenser
 One-way type, Mylar ±5% 50V
- Capacity value

- Examples**
 (1) Capacity value
 0.001μF (1000pF), .102 0.1μF, .104 0.001μF, .182 0.5μF, .584 0.01μF, .103 1μF, .105 0.015μF, .153

REF. DESIG.	PART NO.	DESCRIPTION
PD16-POWER/DEMO CIRCUIT BOARD		
C504	4822 124 22289	Elect 6.8pF 50V
C505	4822 122 40617	Ceramic 0.1μF +80% -20%
C506	4822 122 40617	Ceramic 0.1μF +80% -20%
C511	4822 122 40528	Ceramic 27pF 35%
C512	4822 122 40528	Ceramic 27pF 35%
C513	4822 122 40617	Ceramic 0.1μF +80% -20%
C520	4822 121 42327	Film 470pF 35%
C521	4822 121 42327	Film 470pF 35%
C541	4822 122 40491	Ceramic 0.022μF +80% -20%
C542	4822 122 40491	Ceramic 0.022μF +80% -20%
C581	4822 122 40491	Ceramic 0.022μF +80% -20%
C585	4822 122 40491	Ceramic 0.022μF +80% -20%
C589	4822 122 40491	Ceramic 0.022μF +80% -20%
ΔC872	4822 124 22243	Elect 5800pF 15V
ΔC882	4822 124 22239	Elect 3300pF 25V
ΔC884	4822 124 22239	Elect 3300pF 25V
PD16-SEMICONDUCTORS		
D530	4822 130 80302	Varistor MA27A
D544	4822 130 80306	Diode 1S5173, etc.
ΔD671	4822 130 80907	Diode 2SV920
ΔD817	4822 130 80907	Diode 2SV920
ΔD817	4822 130 80907	Diode 2SV920
ΔD896	4822 130 32908	Diode RL103E, etc.
O501	4822 209 71001	IC SAA7210
O502	4822 209 70422	IC μPD41416C-20
O503	4822 209 72545	IC SAA7220A
O504	4822 209 83641	IC IR2339
O506	4822 209 72323	IC 74HC004
O507	4822 130 42052	Transistor 2SC2785(F, F)
O508	4822 130 42052	Transistor 2SC2785(F, F)
O511	4822 130 61438	Transistor 2SA1005(K, L)
O530	4822 130 42052	Transistor 2SC2785(F, F)
O531	4822 130 42052	Transistor 2SC2785(F, F)
ΔQ371	4822 209 83244	IC NJM7805FA
ΔQ381	4822 209 70084	IC NJM7812FA
ΔQ382	4822 209 73954	IC NJM7912FA
ΔQ383	4822 130 60353	Transistor 2SA1358(O, Y)
PD16-MISCELLANEOUS		
ΔF871	4822 253 30022	Fuse T1.25A 250V
ΔF881	4822 253 20017	Fuse T800mA 250V
ΔF892	4822 253 20017	Fuse T800mA 250V
JG01	4822 290 40296	Terminal, Earth
JG02	4822 290 40296	Terminal, Earth
JG03	4822 290 40296	Terminal, Earth
J501	4822 265 20289	Plug, 2P
J502	4822 321 22588	Jack, Optical
J503	4822 265 20354	Terminal, 1P, RCA
J504	4822 265 20354	Terminal, 1P, RCA

REF. DESIG.	PART NO.	DESCRIPTION
J871	4822 256 30239	Jack, Fuse Holder
J890	4822 256 40604	Plug, 3P
J881	4822 256 30239	Jack, Fuse Holder
J882	4822 256 30239	Jack, Fuse Holder
L505	4822 142 60388	Pulse Transformer
L506	4822 142 60388	Pulse Transformer
X501	4822 242 74395	Crystal 11.2889MHz
PM16-FEATURE μ-COM CIRCUIT BOARD		
PM16-CAPACITORS		
CF11	4822 122 32703	Ceramic 330pF ±10%, Chip
CF12	4822 122 33111	Ceramic 330pF ±5%, Chip
CF13	4822 122 32703	Ceramic 330pF ±10%, Chip
CF14	4822 122 32869	Ceramic 0.047μF +80% -20%
CF21	4822 122 32703	Ceramic 330pF ±10%, Chip
CF29	4822 122 32703	Ceramic 330pF ±10%, Chip
CF38	4822 122 32703	Ceramic 330pF ±10%, Chip
CF43	4822 122 32703	Ceramic 330pF ±10%, Chip
CF51	4822 122 40306	Ceramic 0.047μF +80% -20%
CF67	4822 122 32703	Ceramic 330pF ±10%, Chip
CF85	4822 122 32703	Ceramic 330pF ±10%, Chip
CF87	4822 122 32703	Ceramic 330pF ±10%, Chip
CF91	4822 133 32703	Ceramic 330pF ±10%, Chip
PM16-RESISTORS, CHIP (All Resistors are 1% and 1/10W)		
RF14	4822 111 90895	10kΩ
RF15	4822 111 90895	10kΩ
RF16	4822 111 90895	10kΩ
RF19	4822 111 90895	10kΩ
RF20	4822 111 90895	10kΩ
RF21	4822 111 90895	10kΩ
RF22	4822 111 90895	10kΩ
RF26	4822 111 90894	1kΩ
RF27	4822 111 91414	10Ω
RF28	4822 111 90906	2.2kΩ
RF29	4822 111 91414	10Ω
RF30	4822 111 90894	1kΩ
RF32	4822 111 90918	4.7kΩ
RF33	4822 111 90918	4.7kΩ
RF51	4822 111 91139	6.8kΩ
DF03	4822 130 43408	Diode MA151WK, Chip
DF05	4822 130 43408	Diode MA151WK, Chip
DF51	4822 130 33948	Zener 5.6V
DM01	4822 130 80345	Zener 8.2V, Chip
DM02	4822 130 80345	Zener 8.2V, Chip
OF01	4822 209 11497	IC MSM83C154
OF02	4822 209 11496	IC MSM80C51
OF03	4822 209 51273	IC MSM2816A
OF07	4822 130 60712	Transistor UN2214, Digital
OF08	4822 130 60712	Transistor UN2214, Digital
OF10	4822 130 60713	Transistor UN2214, Digital
OF11	4822 209 73949	IC P8T524D

REF. DESIG.	PART NO.	DESCRIPTION
QM01	4822 209 83803	IC L81645N
QM02	4822 209 83803	IC L81645N
QM03	4822 130 60712	IC Transistor UN2214, Digital
PM16-MISCELLANEOUS		
JF10	4822 265 10117	Plug, 5P
JF21	4822 265 10158	Plug, 2P
LM01	4822 156 10676	Choke Coil 47μF
W202	4822 321 22412	Connective Cord, 7P
XF01	4822 242 71781	Ceramic Vibrator 12.0MHz
XF02	4822 242 71781	Ceramic Vibrator 12.0MHz
PP46-POWER SWITCH CIRCUIT BOARD		
ΔGH01	4822 122 40305	Ceramic Cap. 0.01μF 400V
ΔSH01	4822 276 11441	Push Switch, Power
PS26-TEN KEYS CIRCUIT BOARD		
SS01	4822 276 11569	Push Switch
SS15	4822 276 11569	Push Switch
PV16-SERVO CIRCUIT BOARD		
PV16-CAPACITORS		
C201	4822 124 90357	Elect 2.2μF 50V
C257	4822 124 40464	Elect 4.7μF 35V (BP)
C282	4822 122 40491	Ceramic 0.022μF +80% -20%
PV16-RESISTORS		
R211	4822 116 80256	5.62MΩ ±1% 1/8W
R212	4822 116 80256	5.62MΩ ±1% 1/8W
R231	4822 111 41271	10Ω ±5% 1/8W
R232	4822 111 41271	10Ω ±5% 1/8W
R233	4822 116 83696	120Ω ±5% 1/8W, Fusible
R234	4822 116 83696	120Ω ±5% 1/8W, Fusible
R254	4822 116 80261	91kΩ ±1% 1/8W
R274	4822 116 80262	13kΩ ±1% 1/8W
R275	4822 116 80261	90.9kΩ ±1% 1/8W
R277	4822 116 80255	357kΩ ±1% 1/8W
PV16-SEMICONDUCTORS		
D205	4822 130 33305	Diode 1S5133, etc.
D263	4822 130 32191	Zener RD1.5E-6C
D271	4822 130 42052	Diode 1S5133, etc.
D272	4822 130 33305	Diode 1S5133, etc.
D274	4822 130 33305	Diode 1S5133, etc.
D401	4822 130 33305	Diode 1S5133, etc.
D401	4822 130 32956	Zener 5.6V
Q201	4822 209 80401	IC NJM4558D
Q202	4822 130 42951	Transistor 2SA1175(F, F)
Q203	4822 130 42052	Transistor 2SC2785(F, F)
Q204	4822 130 60354	Transistor 2SC3421(O, Y)
Q206	4822 130 60353	Transistor 2SA1358(O, Y)
Q231	4822 130 60353	Transistor 2SA1358(O, Y)
Q232	4822 130 60354	Transistor 2SC3421(O, Y)
Q233	4822 209 83643	IC IR3741
Q251	4822 209 80401	IC NJM4558D
Q262	4822 130 42951	Transistor 2SA1175(F, F)

REF. DESIG.	PART NO.	DESCRIPTION
PV26-SEMICONDUCTORS		
D301	4822 130 80274	Zener 2.4V, Chip
D302	4822 130 43408	Diode MA151WK, Chip
D303	4822 130 43408	Diode MA151WK, Chip
D304	4822 130 32868	Diode MA153, Chip
D305	4822 130 32955	Zener 5.1V, Chip
D306	4822 130 32635	Diode MA151K, Chip
Q301	4822 209 71675	IC NJM2902M
Q302	4822 209 71675	IC NJM2902M
Q303	4822 209 71675	IC NJM2902M
Q304	4822 209 71676	IC NJM2901M
Q305	4822 209 11607	IC 4030
Q306	4822 209 83368	IC 4053
Q307	4822 209 71451	IC NJM4558M
Q308	4822 130 60658	Transistor 2SC2351, Chip
Q309	4822 209 83363	IC FMW1
Q311	4822 209 83363	IC FMW1
Q312	4822 130 42733	Transistor 2SA1162(G), Chip
Q314	4822 130 60656	Transistor UN2210, Digital
Q315	4822 130 43398	Transistor 2SC2712(GR), Chip
Q316	4822 130 60657	Transistor 2SC1009, Chip
Q317	4822 130 60657	Transistor 2SC1009, Chip
Q318	4822 130 60656	Transistor UN2210, Digital
PV26-MISCELLANEOUS		
J301	4822 267 50871	Jack, 4P
J302	4822 267 50871	Jack, 16P
PY16-DISPLAY CIRCUIT BOARD		
PY16-CAPACITORS		
CY02	4822 122 32669	Ceramic 0.047 μ F +80% -20%, Chip
CY04	4822 122 32693	Ceramic 33 μ F \pm 5%, Chip
CY05	4822 133 32693	Ceramic 33pF \pm 5%, Chip
CY07	4822 122 32697	Ceramic 2200pF \pm 10%, Chip
CY14		
PY16-RESISTORS, CHIP (All Resistors are \pm 5% and 1/10W)		
RY01	4822 111 90901	150K Ω
RY05		
RY06	4822 111 90895	10K Ω
RY13		
RY16	4822 111 90922	5.6K Ω
RY17	4822 111 90922	5.6K Ω
RY18	4822 111 90922	5.6K Ω
RY19	4822 111 91139	6.8K Ω
RY20	4822 111 90922	5.6K Ω
RY21	4822 111 90922	5.6K Ω
PY16-SEMICONDUCTORS		
DY01	4822 130 32635	Diode MA151K, Chip
DY05		
QY01	4822 209 71677	IC LC6554D
QY02	4822 130 42731	Transistor UN2114, Chip
QY06		
QY15	4822 209 73951	IC PST523D

REF. DESIG.	PART NO.	DESCRIPTION
PY16-MISCELLANEOUS		
SY01	4822 276 11559	Push Switch, Stop
SY02	4822 276 11559	Push Switch, Pause
SY03	4822 276 11559	Push Switch, Play
SY05	4822 276 11559	Push Switch, PREV
SY06	4822 276 11559	Push Switch, NEXT
SY07	4822 276 11559	Push Switch, FTS
SY08	4822 276 11559	Push Switch, Time
SY10	4822 276 11559	Push Switch, A B
SY11	4822 276 11559	Push Switch, Repeat
SY13	4822 276 11559	Push Switch, Revers
SY14	4822 276 11559	Push Switch, FF
SY15	4822 276 11559	Push Switch, Previous
SY16	4822 276 11559	Push Switch, Next
VY01	4822 130 90441	Display Unit
XY01	4822 242 71495	Ceramic Vibrator 3MHz
ZY01	4822 130 81183	Photo Unit

NOTE ON SAFETY:

Symbol Δ Fire or electrical shock hazard. Only original parts should be used to replace any part marked with symbol Δ . Any other component substitution (other than original type), may increase risk of fire or electrical shock hazard.

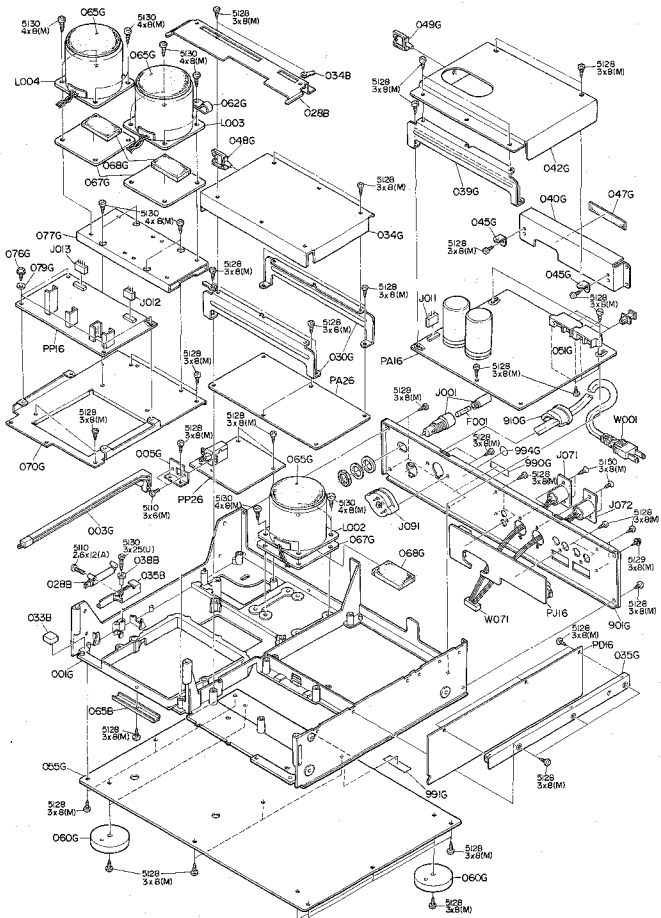

REF. DESIG.	PART NO.	DESCRIPTION
028B	4822 464 50493	Piston, Dumper
033B	4822 462 41011	Buffer
035B	4822 402 61229	Bracket, Dumper
036B	4822 417 11031	Support, Link
065B	4822 443 51101	Cover
003G	4822 402 50237	Link, Power Switch
060G	4822 462 71577	Leg
076G	4822 502 12511	B.T. Screw B3 x 8
079G	4822 466 50192	Sheet, Power P.W. Board
910G	4822 326 50157	Bushing, AC Power Cord
991G	4822 690 70229	Label, Caution
994G	4822 454 11873	Indicator, Made in Japan
Δ F001	4822 253 30025	Fuse 2A 250V
Δ J001	4822 256 30233	Jack, Fuse Holder
J011	4822 265 10093	Jack, 3P
J012	4822 265 10093	Jack, 3P
J013	4822 265 30557	Jack, 4P
J071	4822 286 20415	Plug, Cannon
J072	4822 265 20415	Plug, Cannon
Δ J091	4822 272 10236	Voltage Selector
Δ LO02	4822 146 21401	Power Transformer, Audio
Δ LO03	4822 146 21402	Power Transformer, Lamp/Relay
Δ LO04	4822 146 21403	Power Transformer, Digital

12. DA-12 EXPLODED VIEW AND PARTS LIST

Model DA-12

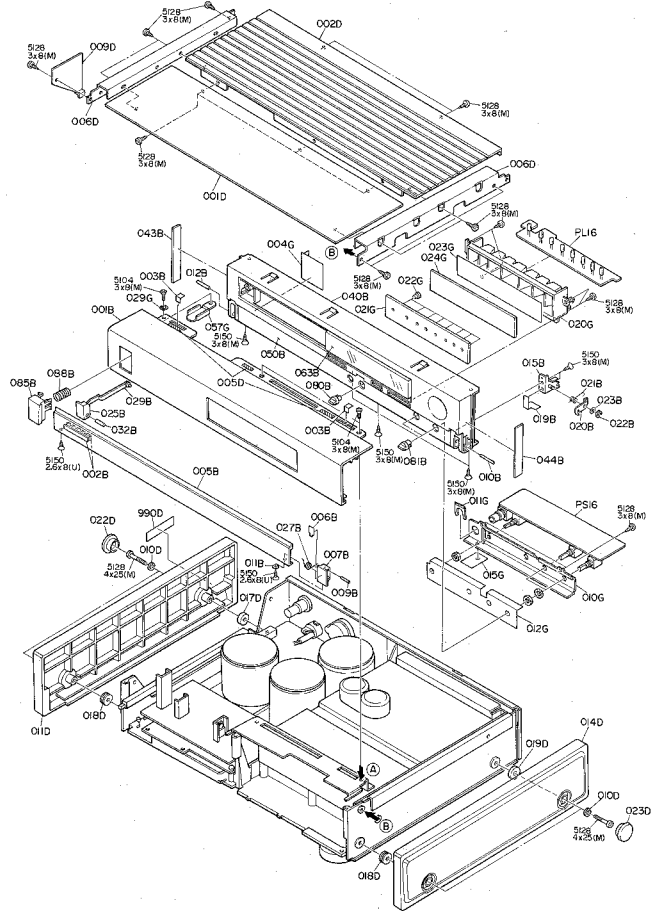

REF. DESIG.	PART NO.	DESCRIPTION
001B	4822 444 40287	Front Panel
002B	4822 458 10895	Badge
005B	4822 532 52078	Spacer
005B	4822 454 30427	Escutcheon, Front Door
007B	4822 417 11032	Hinge (R)
009B	4822 535 92367	Shaft, Lock
010B	4822 535 92368	Shaft, Hinge (R)
012B	4822 535 92368	Shaft, Hinge (L)
015B	4822 402 61225	Bracket (K), Lock Hook
020B	4822 402 61096	Hook, Lock
021B	4822 492 42171	Spring, Lock
022B	4822 532 11301	RG Ring, E Type $\phi 2.5$
022B	4822 532 52081	Washer
025B	4822 417 11033	Hinge (L)
027B	4822 492 42172	Spring, Open
029B	4822 402 50243	Joint
032B	4822 535 92369	Shaft
050B	4822 454 30428	Escutcheon, Front Window
063B	4822 450 61315	Window
080B	4822 412 21006	Knob, Level
081B	4822 412 21007	Knob, Rotary SW.
088B	4822 492 51927	Spring, Power SW.
001D	4822 444 50615	Lid, Top Cover; Front
002D	4822 444 20412	Lid, Top Cover; Rear
005D	4822 462 41094	Buffer
010D	4822 530 70385	Spring Washer
011D	4822 444 40285	Side Panel (L)
014D	4822 444 40285	Side Panel (R)
017D	4822 462 71678	Buffer
018D	4822 532 52077	Collar (K)
019D	4822 462 71678	Buffer
027D	4822 444 60607	Cap (L)
023D	4822 444 60607	Cap (R)
990D	4822 600 70337	Label
011G	4822 462 41037	Stopper, Phono Jack
021G	4822 458 40646	Mask
022G	4822 381 11041	Lens
029G	4822 530 60311	RG Ring, CS Type $\phi 3$

13. DA-12 ELECTRICAL PARTS LIST

ASSIGNMENT OF COMMON PARTS CODES.

RESISTOR

- R***: (1) GD05 --- 140, Carbon film fixed resistor, $\pm 5\%$, 1/4W
 R***: (2) GD05 --- 160, Carbon film fixed resistor, $\pm 5\%$, 1/6W

① --- Resistance value

Examples

① Resistance value	0 10...001	100...100	1k0...102	100k0...104
	0 50...005	180...180	27k0...272	880k0...694
	10...100	1000...101	10k0...103	1Mk0...105
	8.80...068	3900...391	22k0...223	4.7Mk0...475

(Note) Please distinguish 1/4W from 1/6W by the shape of parts used actually.

C***: CERAMIC CAP.

- (1) DD1 --- 370, Ceramic condenser
 Disc type
 Temp. coeff. P350 ~ N1000, 50V

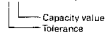

Examples

① Tolerance [Capacity deviation]	$\pm 0.25pF \dots 0$
	$\pm 0.5pF \dots 1$
	$\pm 5\% \dots 5$

* Tolerance of COMMON PARTS handled here are as follows:

0.5pF ~ 5pF	$\pm 0.25pF$
5pF ~ 10pF	$\pm 0.5pF$
12pF ~ 500pF	$\pm 5\%$

② Capacity value

0.5pF...005	3pF...030	100pF...101
1pF...010	10pF...100	220pF...221
1.5pF...015	47pF...470	560pF...561

C***: CERAMIC CAP.

- (1) DK16 --- 300, High dielectric constant ceramic condenser
 Disc type
 Temp. chara. 2B4, 50V



Example

① Capacity value	100pF...101	1000pF...102	10000pF...103
	470pF...471	2200pF...222	

C***: ELECTROLY CAP. (E), FILM CAP. (F)

- (1) EA --- 10, Electrolytic condenser
 One-way lead type, Tolerance $\pm 20\%$



Examples

① Capacity value	0.1 μ F...104	4.7 μ F...475	100 μ F...107
	0.33 μ F...334	10 μ F...106	330 μ F...337
	1 μ F...105	22 μ F...226	1100 μ F...108
			2200 μ F...228

② Working voltage

6.3V...006	25V...025
10V...010	35V...035
16V...016	50V...050

- (2) DF15 --- 350, Plastic film condenser
 One-way type, Mylar $\pm 5\%$, 50V



Examples

① Capacity value	0.001 μ F (1000pF) ... 102	0.1 μ F ... 104
	0.0015 μ F ... 182	0.56 μ F ... 564
	0.01 μ F ... 103	1 μ F ... 105
	0.015 μ F ... 153	

REF. DESIG.	PART NO.	DESCRIPTION
		PA16-AUDIO DAC CIRCUIT BOARD
		PA16-CAPACITORS
C301		
?	4822 122 40491	Ceramic 0.022 μ F +80% -20%
C305		
C610	4822 122 40617	Ceramic 0.1 μ F +80% -20%
C611	4822 122 40617	Ceramic 0.1 μ F +80% -20%
C635	4822 121 42713	Film 680pF $\pm 5\%$
C636	4822 124 90058	Elect 47 μ F 25V
C637	4822 122 40617	Ceramic 0.1 μ F +80% -20%
C638	4822 122 40617	Ceramic 0.1 μ F +80% -20%
C639	4822 122 40617	Ceramic 0.1 μ F +80% -20%
C640	4822 124 90058	Elect 47 μ F 25V
C641	4822 124 90058	Elect 47 μ F 25V
C651	4822 124 90386	Elect 10 μ F 25V
C652	4822 124 90386	Elect 10 μ F 25V
C653	4822 121 51282	Film 2400pF $\pm 2\%$
C654	4822 121 51282	Film 2400pF $\pm 2\%$
C655	4822 121 51281	Film 0.018 μ F $\pm 2\%$
C656	4822 121 51281	Film 0.018 μ F $\pm 2\%$
C657	4822 121 51283	Film 5600pF $\pm 2\%$
C658	4822 121 51283	Film 5600pF $\pm 2\%$
C663	4822 121 51126	Film 2200pF $\pm 2\%$
C664	4822 121 51126	Film 2200pF $\pm 2\%$
C665	4822 121 51144	Film 1000pF $\pm 2\%$
C666	4822 121 51144	Film 1000pF $\pm 2\%$
C669	4822 123 30093	Mica 5pF $\pm 0.5pF$
C670	4822 123 30093	Mica 5pF $\pm 0.5pF$
C671	4822 123 30096	Mica 47pF $\pm 5\%$
C672	4822 123 30096	Mica 47pF $\pm 5\%$
C673	4822 123 30093	Mica 5pF $\pm 0.5pF$
C674	4822 123 30093	Mica 5pF $\pm 0.5pF$
C675	4822 124 90387	Elect 220 μ F 6.3V
C676	4822 124 90387	Elect 220 μ F 6.3V
C677	4822 124 90387	Elect 220 μ F 6.3V
C678	4822 124 90387	Elect 220 μ F 6.3V
C690	4822 124 90386	Elect 10 μ F 25V
C691		
?	4822 124 22238	Elect 100 μ F 25V
C698		
C842	4822 122 40617	Ceramic 0.1 μ F +80% -20%
C844	4822 122 40617	Ceramic 0.1 μ F +80% -20%
C845	4822 122 40617	Ceramic 0.1 μ F +80% -20%
C846	4822 122 40617	Ceramic 0.1 μ F +80% -20%
C853	4822 124 90058	Elect 47 μ F 25V
C854	4822 124 90058	Elect 47 μ F 25V
C855	4822 124 22242	Elect 470 μ F 25V
C856	4822 124 22242	Elect 470 μ F 25V
		PA16-RESISTORS
R622	4822 116 52891	10 Ω $\pm 2\%$ $\times W$
R661	4822 116 53212	4.64K Ω $\pm 2\%$ $\times W$
R652	4822 116 53212	4.64K Ω $\pm 2\%$ $\times W$
R653	4822 116 53377	2.74K Ω $\pm 2\%$ $\times W$
R654	4822 116 53377	2.74K Ω $\pm 2\%$ $\times W$
R655	4822 116 53185	1.47K Ω $\pm 2\%$ $\times W$
R656	4822 116 53185	1.47K Ω $\pm 2\%$ $\times W$
R657	4822 116 53393	825 Ω $\pm 2\%$ $\times W$
R658	4822 116 53393	825 Ω $\pm 2\%$ $\times W$
R665	4822 116 80262	2.37K Ω $\pm 2\%$ $\times W$

REF. DESIG.	PART NO.	DESCRIPTION
R666	4822 116 80262	2.37K Ω $\pm 2\%$ $\frac{1}{4}W$
R667	4822 116 80262	2.37K Ω $\pm 2\%$ $\frac{1}{4}W$
R668	4822 116 80262	2.37K Ω $\pm 2\%$ $\frac{1}{4}W$
R675	4822 116 53772	3.32K Ω $\pm 2\%$ $\frac{1}{4}W$
R676	4822 116 53772	3.32K Ω $\pm 2\%$ $\frac{1}{4}W$
R677	4822 116 53241	21.5K Ω $\pm 2\%$ $\frac{1}{4}W$
R678	4822 116 53241	21.5K Ω $\pm 2\%$ $\frac{1}{4}W$
R679	4822 116 53791	1.54K Ω $\pm 2\%$ $\frac{1}{4}W$
R680	4822 116 53791	1.54K Ω $\pm 2\%$ $\frac{1}{4}W$
R683	4822 116 53781	56.2 Ω $\pm 2\%$ $\frac{1}{4}W$
R684	4822 116 53781	56.2 Ω $\pm 2\%$ $\frac{1}{4}W$
R691 ? R698	4822 116 52892	100 Ω $\pm 5\%$ $\frac{1}{4}W$
R853	5322 116 53214	562 Ω $\pm 2\%$ $\frac{1}{4}W$
R854	5322 116 53214	562 Ω $\pm 2\%$ $\frac{1}{4}W$
R855	4822 116 53079	3.83K Ω $\pm 2\%$ $\frac{1}{4}W$
R856	4822 116 53079	3.83K Ω $\pm 2\%$ $\frac{1}{4}W$
R857	4822 116 60331	1K Ω $\pm 5\%$ 1W
R858	4822 116 60331	1K Ω $\pm 5\%$ 1W
R859	4822 116 52966	1.21K Ω $\pm 2\%$ $\frac{1}{4}W$
R860	4822 116 52966	1.21K Ω $\pm 2\%$ $\frac{1}{4}W$
R861	4822 116 53297	1.78K Ω $\pm 2\%$ $\frac{1}{4}W$
R862	4822 116 53297	1.78K Ω $\pm 2\%$ $\frac{1}{4}W$
R863	4822 116 52956	1.21K Ω $\pm 2\%$ $\frac{1}{4}W$
R864	4822 116 52956	1.21K Ω $\pm 2\%$ $\frac{1}{4}W$
PA16-SEMICONDUCTORS		
D851 ? D854	4822 130 33074	Diode 30DF2
D855	4822 130 33664	Zener HZ6L
D856	4822 130 33664	Zener HZ6L
Q319	4822 209 73985	IC TC74HC153P
Q521	4822 209 72969	IC TDA1541A
Q651	4822 130 70226	IC NJM5534D
Q652	4822 130 70226	IC NJM5534D
Q653	4822 130 70226	IC NJM5534D
Q654	4822 130 70226	IC NJM5534D
Q655	4822 130 42842	F.E.T. 2SK372(GR, BL)
Q656	4822 130 42842	F.E.T. 2SK372(GR, BL)
Q657	4822 209 70226	IC NJM5534D
Q658	4822 209 70226	IC NJM5534D
Q851	4822 130 43031	Transistor 2SB507(D)
Q852	4822 130 43323	Transistor 2SD313(D)
Q853	4822 130 42076	Transistor 2SA1048(GR)
Q854	4822 130 60839	Transistor 2SC2458(I, Y)
Q855	4822 130 42581	Transistor 2SA1175(FF, EF)
Q856	5322 130 42052	Transistor 2SC2785(FF, EF)
PA16-MISCELLANEOUS		
J301	4822 264 30217	Jack, Optical Input
J302	4822 264 30217	Jack, Optical Input
J303	4822 264 30217	Jack, Optical Input
J304	4822 264 22588	Jack, Optical Output
J322	4822 265 40771	Jack, 7P
J323	4822 265 30641	Plug, 2P
J650	4822 265 40771	Jack, 7P
J653	4822 265 30641	Plug, 2P
J654	4822 265 30641	Plug, 2P
J861	4822 265 20205	Plug, 3P
J862	4822 265 30639	Plug, 3P

REF. DESIG.	PART NO.	DESCRIPTION
JG31	4822 290 40296	Terminal, Earth
JG61	4822 290 40296	Terminal, Earth
JG82	4822 290 40296	Terminal, Earth
L301	4822 157 53801	Choke Coil 47 μ H
L302	4822 157 53801	Choke Coil 47 μ H
L303	4822 157 53801	Choke Coil 47 μ H
W321	4822 265 30661	Jack, 7P
PA26-BALANCE AMP CIRCUIT BOARD		
PA26-CAPACITORS		
C701	4822 124 90389	Elect 4.7 μ F 25V
C702	4822 124 90389	Elect 4.7 μ F 25V
C703	4822 124 90389	Elect 4.7 μ F 25V
C704	4822 124 90389	Elect 4.7 μ F 25V
C705	4822 121 51144	Film 1000pF $\pm 2\%$
C706	4822 121 51144	Film 1000pF $\pm 2\%$
C707	4822 124 22238	Elect 100 μ F 25V
C708	4822 124 22238	Elect 100 μ F 25V
C717	4822 121 51209	Film 0.015 μ F $\pm 2\%$
C718	4822 121 51209	Film 0.015 μ F $\pm 2\%$
C731	4822 124 22238	Elect 100 μ F 25V
C732	4822 124 22238	Elect 100 μ F 25V
C733	4822 124 22238	Elect 100 μ F 25V
C734	4822 124 22238	Elect 100 μ F 25V
C737	4822 124 22736	Elect 1000 μ F 25V
C738	4822 124 22736	Elect 1000 μ F 25V
PA26-RESISTORS (All Resistors are $\pm 2\%$ and $\frac{1}{4}W$)		
R701	4822 116 53387	5.62K Ω
R702	4822 116 53387	5.62K Ω
R703	5322 116 53212	4.64K Ω
R704	5322 116 53212	4.64K Ω
R705	4822 116 53387	5.62K Ω
R706	4822 116 53387	5.62K Ω
R709	4822 116 53108	1K Ω
R710	4822 116 53108	1K Ω
R711	4822 116 53387	5.62K Ω
R712	4822 116 53387	5.62K Ω
R713	4822 116 53387	5.62K Ω
R714	4822 116 53387	5.62K Ω
R715	4822 116 53214	562 Ω
R716	4822 116 53214	562 Ω
R717	4822 116 53214	562 Ω
R718	4822 116 53214	562 Ω
R719	4822 116 53784	68.1K Ω
R720	4822 116 53784	68.1K Ω
R731	4822 116 52892	100 Ω $\pm 5\%$
R732	4822 116 52892	100 Ω $\pm 5\%$
R733	4822 116 52892	100 Ω $\pm 5\%$
R734	4822 116 52892	100 Ω $\pm 5\%$
R737	4822 116 53387	5.62K Ω
R738	4822 116 53387	5.62K Ω
PA26-SEMICONDUCTORS		
D703	4822 130 31018	Diode 1S1555, etc.
Q701	4822 209 70226	IC NJM5534D
Q702	4822 209 70226	IC NJM5534D
Q703	4822 209 70226	IC NJM5534D
Q704	4822 209 70226	IC NJM5534D

REF. DESIG.	PART NO.	DESCRIPTION	REF. DESIG.	PART NO.	DESCRIPTION
PA26-MISCELLANEOUS					
J701	4822 265 30641	Plug, 2P	Q401	4822 209 73668	IC YM2637B
J702	4822 265 30641	Plug, 2P	Q407	4822 209 72545	IC SAA7220P/B
J703	4822 265 30662	Plug, 6P	Q411	4822 209 72339	IC TLP570
J706	4822 265 30662	Plug, 6P	Q416	4822 209 72323	IC TC74HC04P
L701	4822 148 80787	Output Transformer (L)	Q451	4822 130 42591	Transistor 2SA1175(FF, EF)
L702	4822 148 80787	Output Transformer (R)	Q452	4822 130 42591	Transistor 2SA1175(FF, EF)
L703	4822 280 20285	Relay SV-12	Q453	5322 130 42052	Transistor 2SC2785(FF, EF)
			Q454	5322 130 42052	Transistor 2SC2785(FF, EF)
			Q455	4822 130 43536	F.E.T. 2SK30ATM(GR)
			Q456	4822 130 43792	Transistor 2SC1815(Y)
PD16-DEMO CIRCUIT BOARD					
PD16-CAPACITORS					
C401	5322 122 32143	Ceramic 22pF ±5%	Q457	4822 130 61357	F.E.T. 2SK161(GR)
C404	4822 122 32185	Ceramic 10pF ±0.5pF	Q458	4822 130 61464	Transistor 2SC2347
C405	4822 122 32185	Ceramic 10pF ±0.5pF	Q459	5322 130 42052	Transistor 2SC2785(FF, EF)
C408	4822 122 40617	Ceramic 0.1μF +80% -20%	Q460	4822 130 61188	Transistor DTC124EX, Digital
C419	4822 122 40617	Ceramic 0.1μF +80% -20%	Q461	4822 130 61321	Transistor DTC124EX, Digital
C421	4822 122 40617	Ceramic 0.1μF +80% -20%	Q462	4822 130 61321	Transistor DTC124EX, Digital
C424	4822 122 40617	Ceramic 0.1μF +80% -20%	Q463	4822 209 73676	IC TC74HC86P
C428	4822 122 40617	Ceramic 0.1μF +80% -20%	Q464	4822 209 73677	IC TC74HC123P
C429	4822 122 40617	Ceramic 0.1μF +80% -20%	Q465	4822 209 73884	IC MC4044P
C451	4822 122 33656	Ceramic 39pF ±5%	Q466	4822 209 72323	IC TC74HC04P
C452	4822 122 33657	Ceramic 56pF ±5%	Q467	4822 209 73678	IC TC74HC393P
C453	4822 121 42713	Film 680pF ±5%	Q468	4822 209 72322	IC TC74HC00P
C455	4822 122 32143	Ceramic 22pF ±5%	Q469	4822 209 73679	IC HD74HC673
C459	4822 122 40617	Ceramic 0.1μF +80% -20%	Q470	4822 209 73681	IC HD74HC674
C462	4822 122 32896	Ceramic 680pF ±5%	Q471	4822 209 73677	IC TC74HC123P
C464	5322 122 31626	Ceramic 100pF ±5%	Q472	4822 209 72333	IC TC74HC74P
C467	4822 122 32486	Ceramic 0.01μF +80% -20%	Q473	4822 209 73676	IC TC74HC08P
C468	5322 122 32143	Ceramic 22pF ±5%	Q474	4822 209 72333	IC TC74HC74P
C470	4822 122 32485	Ceramic 0.01μF +80% -20%	Q475	4822 209 72333	IC TC74HC74P
C472	4822 121 51382	Film 560pF ±5%	Q477	4822 209 72333	IC TC74HC74P
C482	4822 122 40617	Ceramic 0.1μF +80% -20%	Q478	4822 209 73677	IC TC74HC123P
C484	4822 122 40616	Ceramic 0.1μF +80% -20%	Q481	5322 130 42052	Transistor 2SC2785(FF, EF)
C485	4822 122 40617	Ceramic 0.1μF +80% -20%	Q482	5322 130 42052	Transistor 2SC2785(FF, EF)
C487	4822 122 40617	Ceramic 0.1μF +80% -20%	PD16-MISCELLANEOUS		
C489	4822 122 40617	Ceramic 0.1μF +80% -20%	JG41	4822 290 40296	Terminal, Earth
C490	4822 122 40617	Ceramic 0.1μF +80% -20%	JG42	4822 290 40296	Terminal, Earth
C491	4822 122 40491	Ceramic 0.022μF +80% -20%	J404	4822 265 30639	Plug, 3P
C494	4822 122 32486	Ceramic 0.01μF +80% -20%	L451	4822 152 20662	Choke Coil 150μH
PD16-RESISTORS			L452	4822 157 53799	Choke Coil 1.5μH
R452	4822 116 80958	20KΩ ±1% 1/6W	L454	4822 157 53801	Choke Coil 47μH
R453	4822 116 80957	13.3KΩ ±1% 1/6W	L455	4822 157 53801	Choke Coil 47μH
R454	4822 116 80251	100KΩ ±1% 1/6W	X401	4822 242 72334	Crystal 16.9344MHz
R455	4822 116 80959	7.5KΩ ±1% 1/6W	PP26-POWER SWITCH CIRCUIT BOARD		
PD16-SEMICONDUCTORS					
D403	4822 130 33305	Diode 1SS133, etc.			
D451	4822 130 80091	Zener 12V	Δ GH01	4822 122 40305	Ceramic Cap 0.01μF 400V
D452	4822 130 80091	Zener 12V	Δ SH01	4822 276 11141	Push Switch, Power
D453	4822 130 80302	Varistor MA27A			
D454	4822 130 80302	Varistor MA27A			
D455	4822 130 31542	Varicap SVC321SP			
D456					
?	4822 130 33305	Diode 1SS133, etc.			
D463					
D495	4822 130 33305	Diode 1SS133, etc.			
D496	4822 130 33305	Diode 1SS133, etc.			
			PJ16-DIGITAL IN/OUT CIRCUIT BOARD		
			PJ16-CAPACITORS		
C312	4822 122 40617	Ceramic 0.1μF +80% -20%	C313	4822 122 40617	Ceramic 0.1μF +80% -20%
C314	4822 122 40617	Ceramic 0.1μF +80% -20%	C315	4822 122 40491	Ceramic 0.022μF +80% -20%
C319	4822 122 40617	Ceramic 0.1μF +80% -20%	C319	4822 122 40617	Ceramic 0.1μF +80% -20%

REF. DESIG.	PART NO.	DESCRIPTION
PJ16-RESISTORS		
R311	4822 116 80417	75Ω ±1% 1/6W
R316	4822 116 80417	75Ω ±1% 1/6W
R321	4822 116 80417	75Ω ±1% 1/6W
PJ16-SEMICONDUCTORS		
D314	4822 130 33305	Diode 1SS133, etc.
D319	4822 130 33305	Diode 1SS133, etc.
D324	4822 130 33305	Diode 1SS133, etc.
DN05	4822 130 33305	Diode 1SS133, etc.
Q311	4822 130 61447	Transistor 2SC3732(L)
Q316		
Q318	4822 209 73985	IC TC74HC153P
Q320	4822 209 72323	IC TC74HCU04P
PJ16-MISCELLANEOUS		
J311	4822 267 31032	Terminal, 2P; RCA
J312	4822 267 31031	Terminal, 2P; RCA
J651	4822 267 31032	Terminal, 2P; RCA
L311	4822 142 60388	Pulse Transformer
LN01	4822 280 20285	Relay SV-12
PL16-LAMP CIRCUIT BOARD		
JL01	4822 265 10221	Jack, 10P
LL01	4822 134 40928	Lamp 75mA 12V
LL08		
PP16-POWER SUPPLY CIRCUIT BOARD		
PP16-CAPACITORS		
C802	4822 122 40491	Ceramic 0.022μF +80% -20%
Δ C803	4822 124 22243	Elect 6800μF 16V
C807	4822 124 90051	Elect 220μF 25V
Δ C824	4822 124 22239	Elect 3300μF 25V
Δ C825	4822 124 22239	Elect 3300μF 25V
C826	4822 124 90051	Elect 220μF 25V
C827	4822 124 90051	Elect 220μF 25V
C828	4822 122 40491	Ceramic 0.022μF +80% -20%
C832	4822 124 90051	Elect 220μF 25V
PP16-SEMICONDUCTORS		
Δ D801	4822 130 33056	Diode U05B
Δ D802	4822 130 33056	Diode U05B
Δ D803	4822 130 33056	Diode U05B
Δ D804	4822 130 33056	Diode U05B
Δ D805	4822 130 32155	Diode W06B
Δ D806	4822 130 32155	Diode W06B
Δ D807	4822 130 32155	Diode W06B
Δ D808	4822 130 32155	Diode W06B
Δ D813	4822 130 32155	Diode W06B
Δ D814	4822 130 32155	Diode W06B
Δ D821	4822 130 32155	Diode W06B
Δ D822	4822 130 32155	Diode W06B
Δ D823	4822 130 32155	Diode W06B
Δ D824	4822 130 32155	Diode W06B
Δ D831	4822 130 33095	Zener RD6.8E92
D832	4822 130 33799	Zener 4.7V

REF. DESIG.	PART NO.	DESCRIPTION
Δ Q801	4822 209 83824	IC NJM7805
Δ Q802	4822 209 83824	IC NJM7805
Q806	4822 130 42298	Transistor 2SC5365P, etc.
Q810		
Δ Q821	4822 209 70086	IC NJM79M12A
Δ Q822	4822 209 70084	IC NJM7812
Δ Q831	4822 130 60353	Transistor 2SA135E(O, Y)
Q832	4822 130 42591	Transistor 2SA1175E(FF, EF)
PP16-MISCELLANEOUS		
Δ F801	4822 265 20205	Plug, 3P
Δ F802	4822 265 20017	Fuse 800mA 250V
Δ F821	4822 265 20017	Fuse 800mA 250V
Δ F822	4822 265 20017	Fuse 800mA 250V
JG81	4822 290 40296	Terminal, Earth
Δ J801	4822 266 30239	Jack, Fuse Holder
Δ J802	4822 266 30239	Jack, Fuse Holder
J804	4822 265 30641	Plug, 2P
J806	4822 265 30643	Plug, 4P
J820	4822 265 30662	Plug, 6P
Δ J821	4822 266 30239	Jack, Fuse Holder
Δ J822	4822 266 30239	Jack, Fuse Holder
J823	4822 265 20205	Plug, 3P
PS16-FUNCTION SW./PHONE CIRCUIT BOARD		
C925	4822 122 40617	Ceramic Cap. 0.1μF +80% -20%
R900	4822 100 20632	Resistor 10KΩ(A) x 2, Variable
R821	4822 111 20384	Resistor 6.8Ω ±5% 1/4W, Fusible
R922	4822 111 20384	Resistor 6.8Ω ±5% 1/4W, Fusible
D901	4822 130 33305	Diode 1SS133, etc.
DS01	4822 130 33305	Diode 1SS133, etc.
DS13		
Q901	4822 209 83654	IC NJM4556D
Q902	4822 209 83654	IC NJM4556D
Q501	4822 130 60839	Transistor 2SC2458(O, Y)
Q502	4822 130 60839	Transistor 2SC2458(O, Y)
Q503	4822 130 42052	Transistor 2SC2785(FF, EF)
JG91	4822 265 10158	Plug, 2P
J900	4822 267 31026	Jack, Phone
L901	4822 280 20285	Relay SV-12
SS01	4822 273 20312	Rotary Switch
SS02	4822 273 50297	Rotary Switch

NOTE ON SAFETY:

Symbol Δ Fire or electrical shock hazard. Only original parts should be used to replace any part marked with symbol Δ. Any other component substitution (other than original type), may increase risk of fire or electrical shock hazard.

14. RC-12CD EXPLODED VIEW AND PARTS LIST

Model RC-12CD

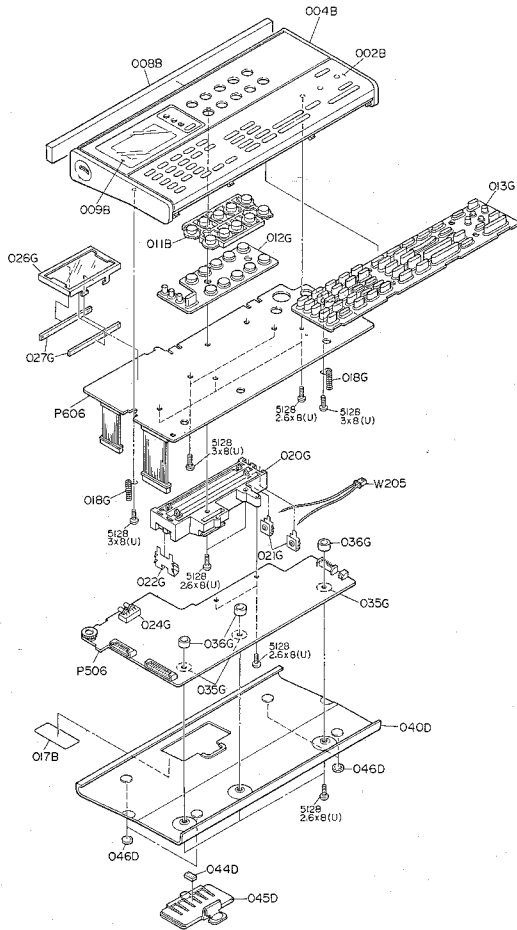

REF. DESIG.	PART NO.	DESCRIPTION
002B	4822 432 30345	Front Panel
004B	4822 432 30344	Case Assembly
008B	4822 450 61307	Window, Front Side
009B	4822 381 11039	Window, LCD
011B	4822 276 80346	Button, Function
040D	4822 432 30346	Lid, Bottom
045D	4822 432 30347	Lid, Battery
046D	4822 462 41064	Leg
012G	4822 276 80344	Contactors, Key
013G	4822 276 80345	Contactors, Key
018G	4822 492 32976	Spring
020G	4822 256 60301	Holder, Battery
021G	4822 290 80846	Contactors (L)
022G	4822 290 80847	Contactors (R)
035G	4822 520 10673	Sustainer

15. RC-12CD ELECTRICAL PARTS LIST

ASSIGNMENT OF COMMON PARTS CODES.

- RESISTOR**
R*** (1) GD05...142, Carbon film fixed resistor, ±5%, 1/4W
R** (2) GD05...160, Carbon film fixed resistor, ±5%, 1/8W
 ⓪ — Resistance value

- Examples**
 ⓪ Resistance value
 0 11k...001 100k...100 14k1...102 100k1...104
 0.5k...005 18k1...180 2.7k1...272 680k1... 684
 1k1...010 100k1...101 10k1...103 1Mk1... 105
 6.8k1...068 390k1...391 22k1...223 4.7Mk1... 476

(Note) Please distinguish 1/4W from 1/8W by the shape of parts used actually.

- C*** CERAMIC CAP.**
 (1) DD1...370, Ceramic condenser
 Disc type
 Temp. coeff. P350 ~ N1000, 50V

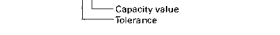

- Examples**
 ⓪ Tolerance (Capacity deviation)
 ±0.25pF...0
 ±0.5pF...1
 ±5%...5
 * Tolerance of COMMON PARTS handled here are as follows:
 0.5pF ~ 5pF...±0.25pF
 5pF ~ 10pF...±0.5pF
 12pF ~ 500pF...±5%
 ⓪ Capacity value
 0.5pF...005 3pF...030 100pF...101
 1pF...010 10pF...100 220pF...221
 1.5pF...015 47pF...470 560pF...561

- C*** CERAMIC CAP.**
 (1) DK16...300, High dielectric constant ceramic condenser
 Disc type
 Temp. chara. 2B4, 50V

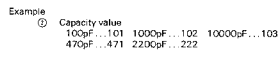

- Example**
 ⓪ Capacity value
 100pF...101 1000pF...102 10000pF...103
 470pF...471 2200pF...222

- C*** ELECTROLY CAP (1/2 FILM CAP (1/2)**
 (1) EA...10, Electrolytic condenser
 One-way lead type, Tolerance ±20%

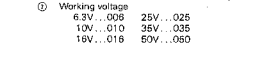

- Examples**
 ⓪ Capacity value
 0.1μF...104 4.7μF...475 100μF...107
 0.33μF...334 10μF...106 330μF...337
 1μF...105 22μF...226 1100μF...108
 2200μF...228
 ⓪ Working voltage
 6.3V...008 25V...025
 10V...010 35V...035
 16V...016 50V...050

- (2) DF15...3F0, Plastic film condenser
 One-way type, Mylar ±5% 50V
 ⓪ Capacity value

- Examples**
 ⓪ Capacity value
 0.001μF (1000pF)...102 0.1μF...104
 0.0015μF...152 0.56μF...564
 0.01μF...103 1μF...105
 0.015μF...153

REF. DESIG.	PART NO.	DESCRIPTION
P506-MAIN CIRCUIT BOARD		
P506-CAPACITORS		
C101	4822 124 22319	Elect. 100μF 6.3V
C106	4822 124 22319	Elect. 100μF 6.3V
C107	4822 124 22476	Elect. 4.7μF 25V
C137	4822 122 52685	Ceramic 0.001μF ±10%
P506-RESISTORS, CHIP (All Resistors are ±5% and 1/10W)		
R101	4822 111 90895	10KΩ
R102	4822 111 90896	100KΩ
R103	4822 111 90822	5.6KΩ
R104	4822 111 90918	4.7KΩ
R106	4822 111 90895	10KΩ
R107	4822 111 90905	68KΩ
R112	4822 111 90897	1MΩ
R113	4822 111 90895	10KΩ
R114	4822 111 90919	27KΩ
R115	4822 111 90896	100KΩ
R117	4822 111 90895	10KΩ
R118	4822 111 90896	100KΩ
R150	4822 100 11451	20KΩ(B), Variable
R152	4822 111 90906	2.2KΩ
R153	4822 111 90896	100KΩ
R154	4822 111 90896	100KΩ
R155	4822 111 91459	22Ω
R156	4822 111 91459	22Ω
R181	4822 111 90907	22KΩ
R192	4822 111 91451	680KΩ
R193	4822 111 90911	27KΩ
R194	4822 111 90907	22KΩ
R195	4822 111 90919	47KΩ
R196	4822 111 90913	33KΩ
R197	4822 111 90896	100KΩ
R198	4822 111 90918	4.7KΩ
R501	4822 116 90803	150Ω
R502	4822 111 90893	100Ω
P506-SEMICONDUCTORS		
D101	4822 130 81052	Zener HZ5ALL
D102	4822 130 32635	Diode, Chip MA-151K
D103	4822 130 32635	Diode, Chip MA-151K
D104	4822 130 32635	Diode, Chip MA-151K
D106	4822 130 32635	Diode, Chip MA-151K
D109	4822 130 81053	L.E.D. TLN105B
D110	4822 130 81053	L.E.D. TLN105B
D119	4822 130 81054	L.E.D. TP5703
Q101	4822 209 73593	Microprocessor M50747-FP
Q102	4822 209 51607	IC TC54256AF
Q103	4822 209 73588	IC 64K
Q104	4822 209 71322	IC 74HC14F
Q105	4822 209 73592	IC 74HC139F
Q106	4822 209 72642	IC 74HC74F
Q111	4822 209 73587	IC PS7520(D)
Q112	4822 130 42733	Transistor 2SA1162(G), Chip
Q113	4822 130 42733	Transistor 2SA1162(G), Chip
Q114	4822 130 61405	Transistor 2SC2411(R), Chip
Q116	4822 130 43398	Transistor 2SC2712(G), Chip
Q129	4822 130 42733	Transistor 2SA1162(G), Chip
Q130	4822 130 43398	Transistor 2SC2712(G), Chip
Q131	4822 130 43398	Transistor 2SC2712(G), Chip

REF. DESIG.	PART NO.	DESCRIPTION
B101	4822 138 10297	P506-MISCELLANEOUS Battery CR2032-1HF
J101	4822 265 20413	Jack, 11P
J102	4822 265 20414	Jack, 15P
J105	4822 265 20412	Jack, 2P
X101	4822 242 72321	Crystal 8MHz
P506-KEY CIRCUIT BOARD		
P506-RESISTORS, CHIP		
R201	4822 116 80974	91KΩ ±1% 1/10W
R202	4822 111 91139	6.8KΩ ±5% 1/10W
R206		
P506-SEMICONDUCTORS		
Q201	4822 209 73591	IC HD44780
Q202	4822 209 73589	IC HD44100H
K201	4822 130 90627	Display Unit

Model DA-12 Specifications

Number of Channels	2 stereo
D/A Converter	16-bit, Fourfold oversampling
Sampling Rate	Compatible with 44.1 KHz and 48 KHz (Automatic Selection)
Frequency Response (with a 44.1 KHz input signal)	
Unbalanced Outputs	2 Hz ~ 20 KHz ± 0.1 dB
BALANCED Outputs	20 Hz ~ 20 KHz $+0.3, -0.6$ dB
Signal-to-noise Ratio	101 dB
Dynamic Range	96 dB
Channel Separation	100 dB
Total Harmonic Distortion	0.0015% (at 1 KHz)
Digital Input Terminals	
COAXIAL 1 and COAXIAL 2	Input Level 0.5 V P-P Input Impedance 75 Ohms
OPTICAL 1 and OPTICAL 2	Input Level $-15 \sim -23$ dBm
Digital Audio Taperecorder Terminals	
COAXIAL Input Terminals	Input Level 0.5 V P-P Input Impedance 75 Ohms
OPTICAL Input Terminals	Input Level $-15 \sim -23$ dBm
COAXIAL Output Terminals	Output Level 0.5 V P-P Output Impedance 75 Ohms
OPTICAL Output Terminals	Output Level $-15 \sim -23$ dBm
Analogue Output Terminals	
Unbalanced Output Terminals	Output Level 2 V rms Output Impedance 100 Ohms Matching Load Impedance: More than 10 K Ohms
BALANCED Output Terminals	Output Level (open load) 3 V rms Output Impedance 100 Ohms Matching Load Impedance: Balanced: 600 Ohms Unbalanced: 600 Ohms ~ 50 K Ohms
HEADPHONE Output Terminal (THD: 0.1%)	Output Level 32 Ohms, 45 mW Matching Load Impedance: 8 Ohms ~ 1000 Ohms
Power Supply	
Voltage	220/240 V
Line Frequency	50 Hz or 60 Hz
Power Consumption	18 W
Dimensions and Weight	
Width	455 mm
Height	103 mm
Depth	345 mm
Weight	14 kg
Accessories	
XLR Connection cord	1 pair

16. TECHNICAL SPECIFICATIONS

Model CD-12 Specifications

Optical Readout System		
Laser	Semi-conductor AlGaAs	
Wave Length	780 nm	
Digital Output Terminals		
Coaxial 1, 2	Output Level	0.5 V P-P
	Output Impedance	75 Ohms
Optical 1, 2	Output Level	-15 ~ -23 dBm
Power Supply		
Voltage	220/240 V	
Line Frequency	50 Hz or 60 Hz	
Power Consumption	15 W	
Temperature Range	5°C ~ 35°C	
Humidity Range	Without Dew	5% ~ 90%
Dimensions and Weight		
Width	455 mm	
Height	103 mm	
Depth	345 mm	
Weight	14 kg	
Accessories		
Coaxial Connection Cord	1 pc.	
Optical Fiber Cable	1 pc.	

Model RC-12CD Specifications

IR Wave Length	950 nm
IR Reach Distance (at 25°C)	7 m
Power Supply	4 pcs. of (R6/SUM-3/Size AA) batteries
Learning Specifications	
	Condition: Align two remote control units head to head
Distance between Two Units	50 mm
Maximum Number of Learning Codes	
D-BUS	296 codes
Others	Approx. 150 codes
Battery Life	More than one year (30 times transmit/day)
Battery Replacement Time	Within 5 minutes
Dimensions and Weight	
Width	260 mm
Height	31 mm
Depth	126 mm
Weight	680 g

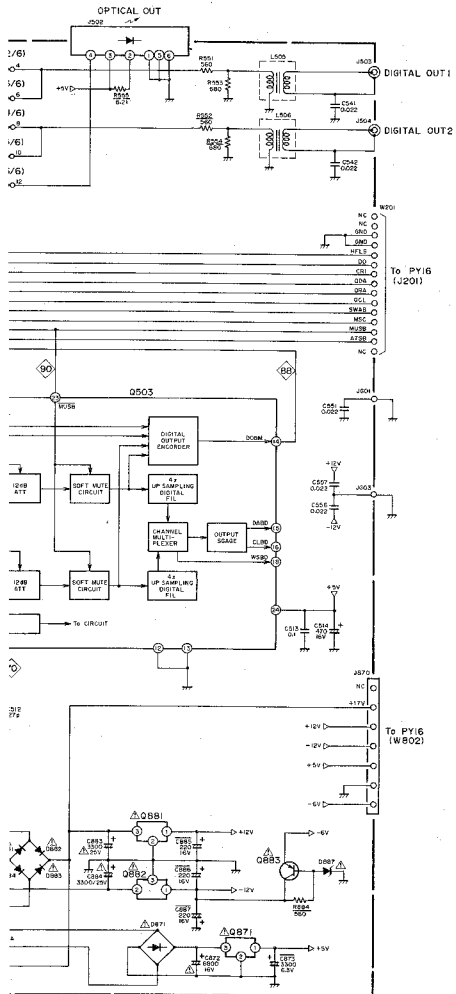

- Q501 SAA7210
- Q502 μ PD41416C-20
- Q503 SAA7220A
- Q504 1R2339
- Q505 PST529C
- Q506 74HC004
- Q507, Q508, Q530, Q531 2SC2785 (FF, EF)
- Q511 2SA1005 (K, L)
- Q871 NJM7805FA
- Q881 NJM7812FA
- Q882 NJM7912FA
- Q883 2SA1358 (O, Y)

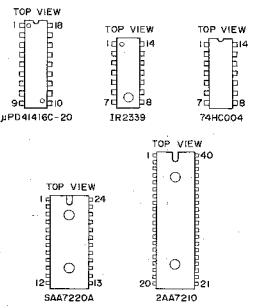
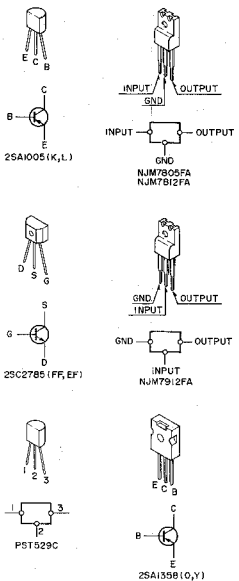

- D530 MA27A
- D544 ~ D549 30V
- D871 92V820
- D881 ~ D886 RL103E
- D887 6.8V

Kind of Common Parts

- RESISTOR**
- R*** (1) GD05 -- 140, Carbon film fixed resistor, $\pm 5\%$ 1/4W
 - R*** (2) GD05 -- 160, Carbon film fixed resistor, $\pm 5\%$ 1/6W
 - C*** : CERAMIC CAP.
 - (1) DD1 -- 370, Ceramic condenser, disc type (titan condenser)
 - Temp. coeff. P350 -- N1000 50V
 - C*** : CERAMIC CAP.
 - (1) DK16 -- 300, High dielectric constant ceramic condenser, disc type (titan variable)
 - Temp. chara. 2B4 50V
 - C*** : ELECTROLY CAP. (---) / FILM CAP. (---)
 - (1) EA ----- 10, Electrolytic condenser, one-way lead type, tolerance $\pm 20\%$
 - (2) DF15 -- 350, Plastic film condenser, one-way type, Mylar, $\pm 5\%$ 50V

* In case of ordering the common parts, please establish the correct parts number of 10 figures by the procedure "ASSIGNMENT OF COMMON PARTS CODES"

"SERVICE INFORMATION IS FOR USE BY QUALIFIED PERSONNEL ONLY - ANY MISADJUSTMENT OR MISALIGNMENT MAY BE TREATED AS A NON-WARRANTY REPAIR BY ANY MARANTZ SERVICE CENTER."

NOTE ON SAFETY:
 Symbol Δ Fire or electrical shock hazard. Only original parts should be used to replace any part marked with symbol Δ . Any other component substitution (other than original type), may increase risk of fire or electrical shock hazard.

Components and wiring are subject to change for modification without notice.

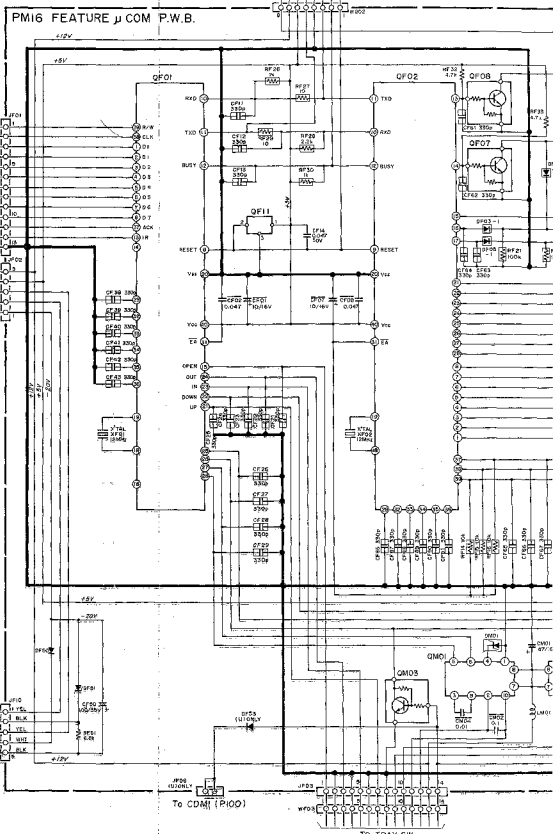
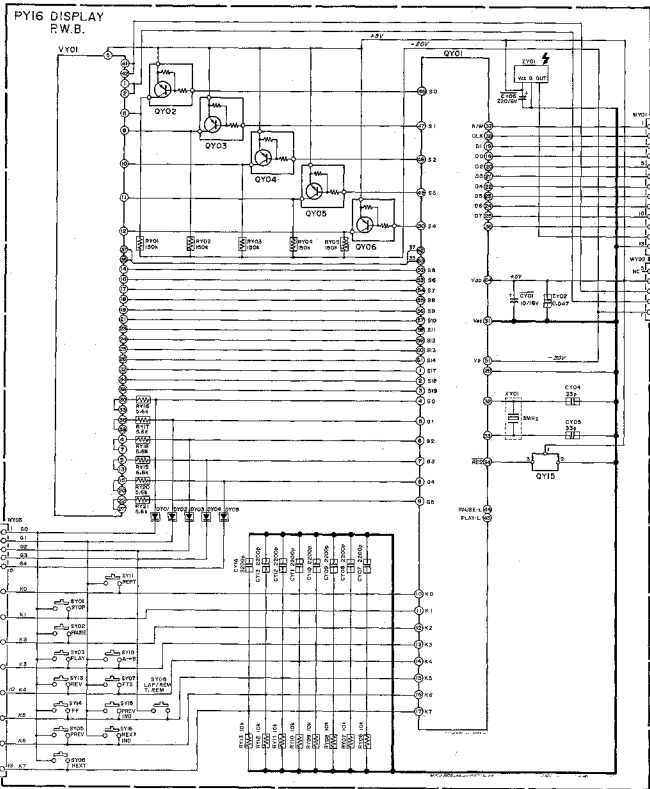
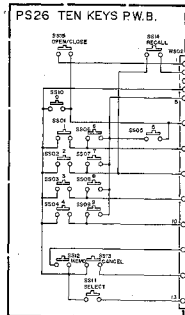

ATURE μ COM P.W.B.

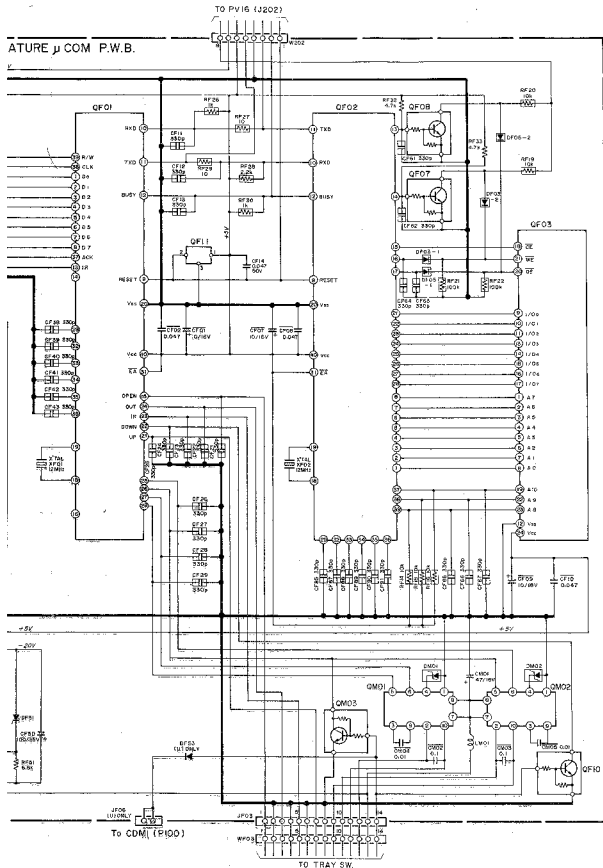

QY01
LC6554D



QY02~QY06
DTA1147K 10K/47K

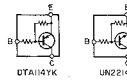

QF11
PST524D

QY15
PST523D



QM01, QM02
LB1645N

QF01
MSM83C154



QF02
MSM80C51



QF03
MSM2816A, XL2816A



QF07, QF08, QF10, QM03
UN2214 10K/47K

DY01~DY06
DF30, DF50

MA151K
DY51, DY52, DF50, DF53



RL103E, DSF10C



DM01, DM02
O2C28-2



DF51
5.6V ZENER

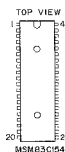

Kind of Common Parts

RESISTOR

- R*** (1) GD05 -- 140, Carbon film fixed resistor, $\pm 5\%$ 1/4W
- R*** (2) GD05 -- 160, Carbon film fixed resistor, $\pm 5\%$ 1/6W

C*** : CERAMIC CAP.

- (1) DD1 --- 370, Ceramic condenser, disc type (titan condenser) Temp. coeff. P390 -- N1000 50V

C*** : CERAMIC CAP.

- (1) DK16 -- 300, High dielectric constant ceramic condenser, disc type (titan variable) Temp. chara. 2B4 50V

C*** : ELECTROLY CAP. (\pm) / FILM CAP. (\pm)

- (1) EA ----- 10, Electrolytic condenser, one-way lead type, tolerance $\pm 20\%$
- (2) DF15 --- 350, Plastic film condenser, one-way type, Mylar, $\pm 5\%$ 50V

* In case of ordering the common parts, please establish the correct parts number of 10 figures by the procedure "ASSIGNMENT OF COMMON PARTS CODES"

"SERVICE INFORMATION IS FOR USE BY QUALIFIED PERSONNEL ONLY - ANY MISADJUSTMENT OR MISALIGNMENT MAY BE TREATED AS A NON-WARRANTY REPAIR BY ANY MARANTZ SERVICE CENTER--"

NOTE ON SAFETY:

Symbol Δ Fire or electrical shock hazard. Only original parts should be used to replace any part marked with symbol Δ . Any other component substitution (other than original type), may increase risk of fire or electrical shock hazard.

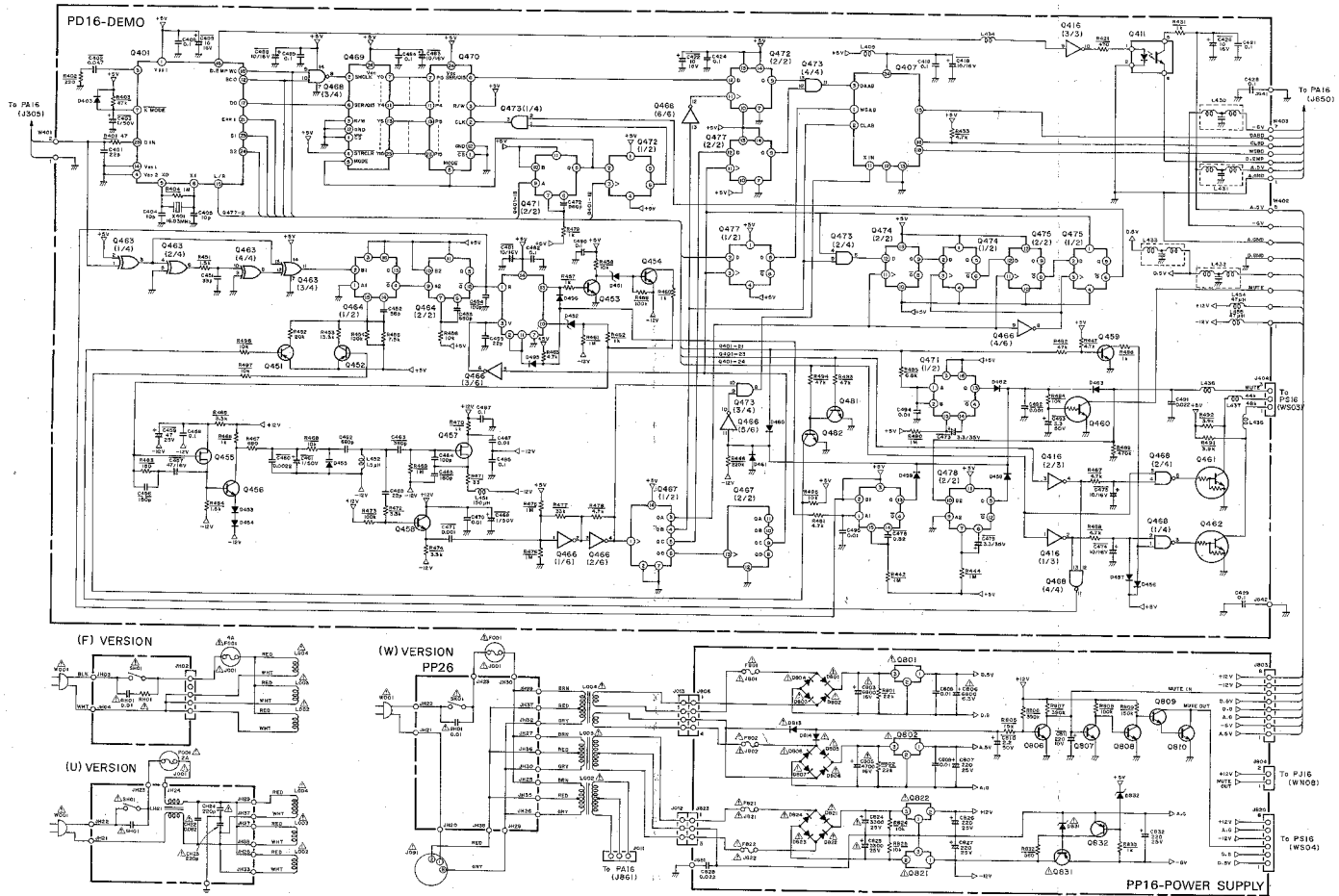

- Q401 YM2637B
- Q407 2A72Z0P/B
- Q411 TLPS70
- Q416,Q466 TC74HC04P
- Q451,Q452,Q832 2SA1754F,EF1
- Q453,Q454,Q459,Q481,Q482 2SC2785(F,F,EF)
- Q455 2SK30ATM
- Q456 2SC161D(Y)
- Q457 2SK161(GR)
- Q458 2SC2347
- Q460 2SC1447B
- Q461,Q462 DT0124EX
- Q463 TC74HC66P
- Q464,Q471,Q478 TC74HC123P
- Q465 MC4044P
- Q467 TC74HC93P
- Q468 TC74HC00P
- Q469 HD74HC673
- Q470 HD74HC674
- Q472,Q474,Q475 TC74HC14P
- Q473 TC74HC14P
- Q477 TC74HC14P
- Q478 TC74HC123P
- Q481 TC74HC14P
- Q482 TC74HC14P
- Q483 TC74HC14P
- Q484 TC74HC14P
- Q485 TC74HC14P
- Q486 TC74HC14P
- Q487 TC74HC14P
- Q488 TC74HC14P
- Q489 TC74HC14P
- Q490 TC74HC14P
- Q491 TC74HC14P
- Q492 TC74HC14P
- Q493 TC74HC14P
- Q494 TC74HC14P
- Q495 TC74HC14P
- Q496 TC74HC14P
- Q497 TC74HC14P
- Q498 TC74HC14P

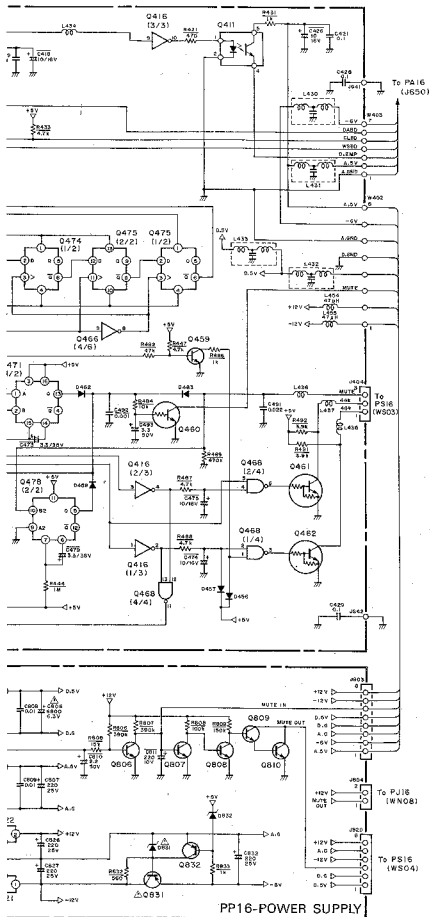

Q401	Q801, Q802	TOP VIEW	
YM28378	NJM7905		
Q407	Q806-Q810	TOP VIEW	
5AAT220P/B	TLP570		
Q411	Q821	TOP VIEW	
TLP570	NJM79M12A		
Q416, Q466	Q822	TOP VIEW	
TC74HC004P	NJM7812		
Q451, Q452	Q831	TOP VIEW	
Q832	2SA1358(Q,Y)		
2SA1175(FF,EF)			
Q453, Q454, Q459	Q403, Q456-Q463	TOP VIEW	
Q481, Q482	D490, D496		
2SC2780(1FF,EF)	1S5176, etc.		
Q495	D451, D452	TOP VIEW	
2SK3047M	12V		
Q456	D453, D454	TOP VIEW	
2SC1815(Y)	MA2TA		
Q457	D455	TOP VIEW	
2SK1816(R)	5V3C15D		
Q458	D801-D804	TOP VIEW	
2SC2347	U05B		
Q460	D805-D808, D813	TOP VIEW	
DTC144TS	D814, D821-D824		
Q461, Q462	W06B		
DTC124EX	D831	TOP VIEW	
Q463	RD6.6E82		
TC74HC86P	D832	TOP VIEW	
4.7V	HD74HC673		
Q464, Q471, Q478	HD74HC674		
TC74HC123P			
Q465		TOP VIEW	
MC4044P			
Q467		TOP VIEW	
TC74HC393P			
Q468		TOP VIEW	
TC74HC00P			
Q469			
HD74HC673			
Q470			
HD74HC674			
Q472, Q474, Q475			
Q477			
TC74HC74P			
Q473			
TC74HC08P			

Kind of Common Parts

- RESISTOR**
- R*** (1) GD06 -- 140, Carbon film fixed resistor, ±5% 1/4W
 - R*** (2) GD05 -- 180, Carbon film fixed resistor, ±5% 1/8W
- CERAMIC CAP.**
- (1) DD1 --- 370, Ceramic condenser, disc type (titan condenser) Temp. coeff. P350 ~ N1000 50V
- C*** : CERAMIC CAP.**
- (1) DK16 -- 300, High dielectric constant ceramic condenser, disc type (titan variable) Temp. chara. 2B4 50V
- ELECTROLY CAP. (⚡)/FILM CAP. (≡)**
- (1) EA --- 10, Electrolytic condenser, one-way lead type, tolerance ±20%
 - (2) DF15 -- 350, Plastic film condenser, one-way type, Mylar, ±5% 50V

* In case of ordering the common parts, please establish the correct parts number of 10 figures by the procedure "ASSIGNMENT OF COMMON PARTS CODES"

"SERVICE INFORMATION IS FOR USE BY QUALIFIED PERSONNEL ONLY - ANY MISADJUSTMENT OR MISALIGNMENT MAY BE TREATED AS A NON-WARRANTY REPAIR BY ANY MARANTZ SERVICE CENTER."

NOTE ON SAFETY:
 Symbol ⚡ Fire or electrical shock hazard. Only original parts should be used to replace any part marked with symbol ⚡. Any other component substitution (other than original type), may increase risk of fire or electrical shock hazard.

Components and wiring are subject to change for modification without notice.

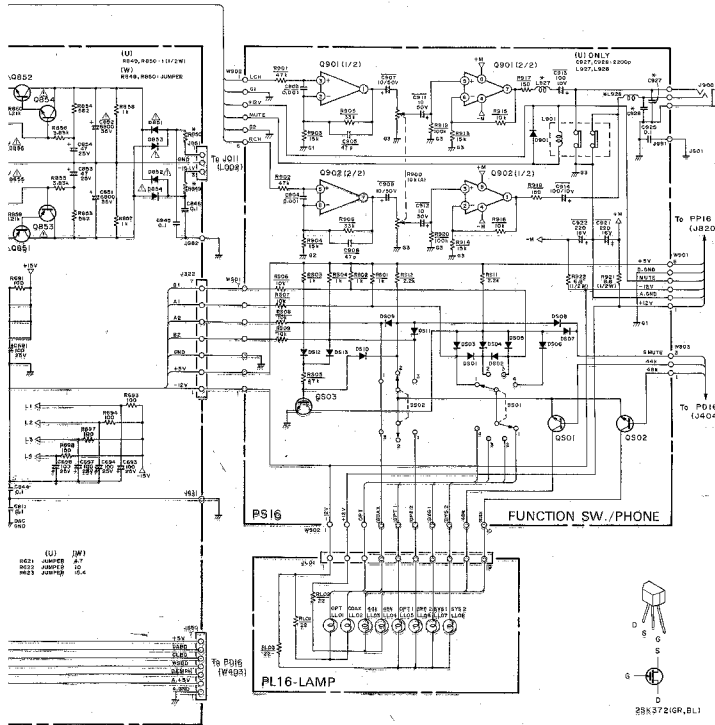

- Q311-Q316
- 2SC3732 (L)
- Q319, Q319
- TC74HC153P
- Q330
- TC74HC04AP
- Q621
- TDA1541A/S1
- Q851-Q854, Q857
- Q858, Q791A-T704
- NJM5534D
- Q655, Q656
- 2SK372 (GR, BL)
- Q851
- 2S8507 (D)
- Q802
- 2SD313 (D)
- Q653
- 2SA1048 (GR)
- Q854, Q801, Q802
- 2SC2456 (O, Y)
- Q855
- 2SA1175 (FF, EF)
- Q856, Q850
- 2SC2785 (FF, EF)
- Q901, Q902
- NJM4556D
- DS14, DS19, DS24
- PS16 (INCOR, DS1) - DS13
- ISS176, etc.
- DS13
- ISS151, etc.
- DS15-2804
- 30DF8
- D855, D856
- NISL (3)
- 2SK372 (GR, BL)

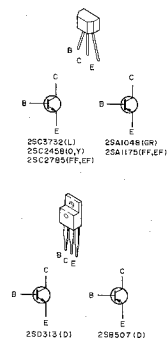
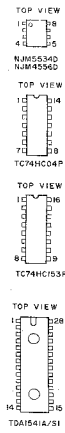

Kind of Common Parts

- RESISTOR**
- R*** (1) GD05 -- 140, Carbon film fixed resistor, $\pm 5\%$ 1/4W
 - R*** (2) GD05 -- 160, Carbon film fixed resistor, $\pm 5\%$ 1/8W
- CAPACITOR**
- C*** : CERAMIC CAP.
 - (1) DD1 --- 370, Ceramic condenser, disc type (titan condenser) Temp. coef. P350 ~ N1000 50V
 - C*** : CERAMIC CAP.
 - (1) DK16 -- 300, High dielectric constant ceramic condenser, disc type (titan variable) Temp. chara. 2B4 50V
 - C*** : ELECTROLY CAP. (\equiv)/FILM CAP. (\equiv)
 - (1) EA ----- 10, Electrolytic condenser, one-way lead type, tolerance $\pm 20\%$
 - (2) DF15 -- 350, Plastic film condenser, one-way type, Mylar, $\pm 5\%$ 50V
- * In case of ordering the common parts, please establish the correct parts number of 10 figures by the procedure "ASSIGNMENT OF COMMON PARTS CODES"

"SERVICE INFORMATION IS FOR USE BY QUALIFIED PERSONNEL ONLY - ANY MISADJUSTMENT OR MISALIGNMENT MAY BE TREATED AS A NON-WARRANTY REPAIR BY ANY MARANTZ SERVICE CENTER--"

NOTE ON SAFETY:
 Symbol Δ : Fire or electrical shock hazard. Only original parts should be used to replace any part marked with symbol Δ . Any other component substitution (other than original type), may increase risk of fire or electrical shock hazard.

Components and wiring are subject to change for modification without notice.

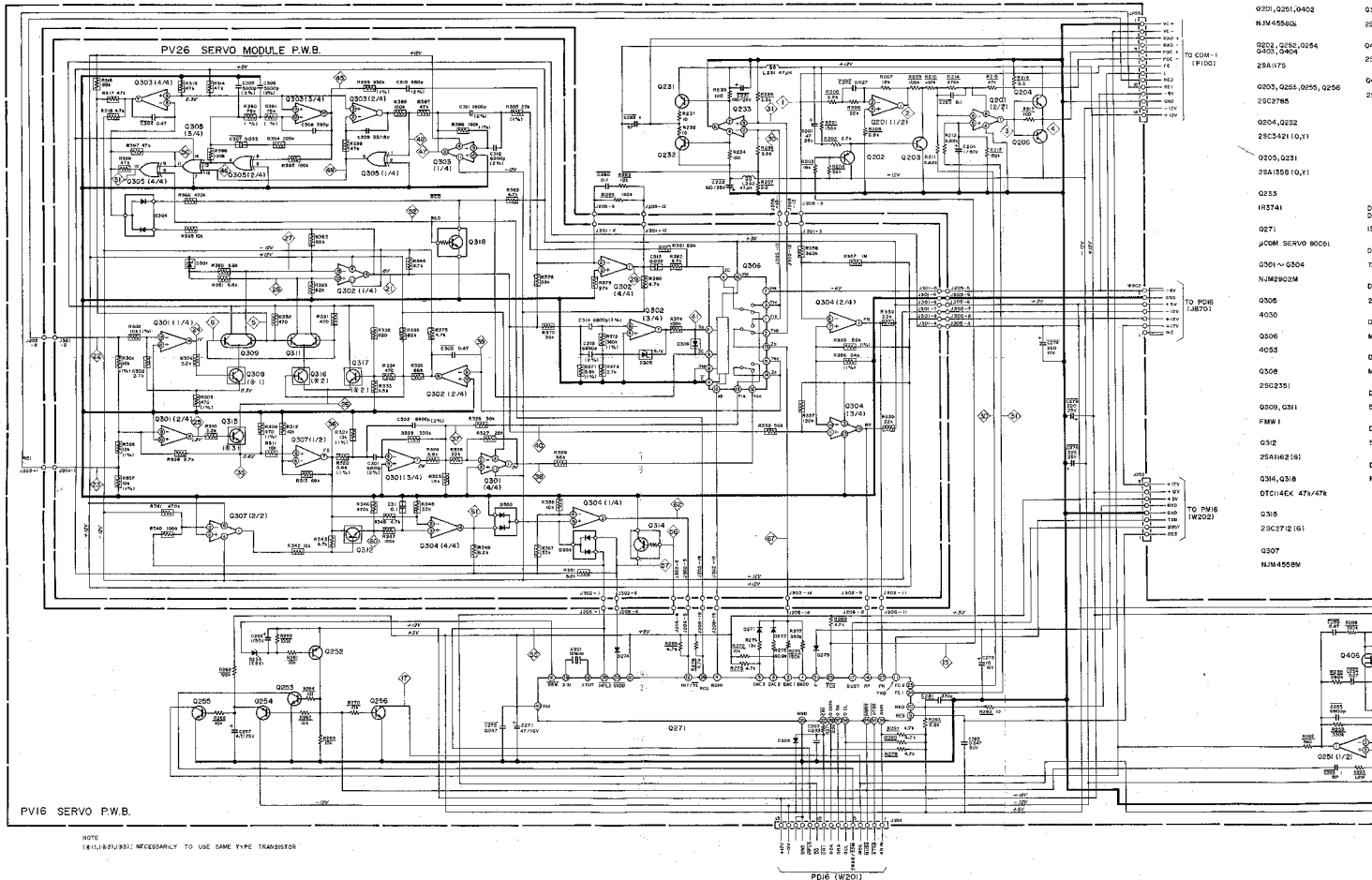

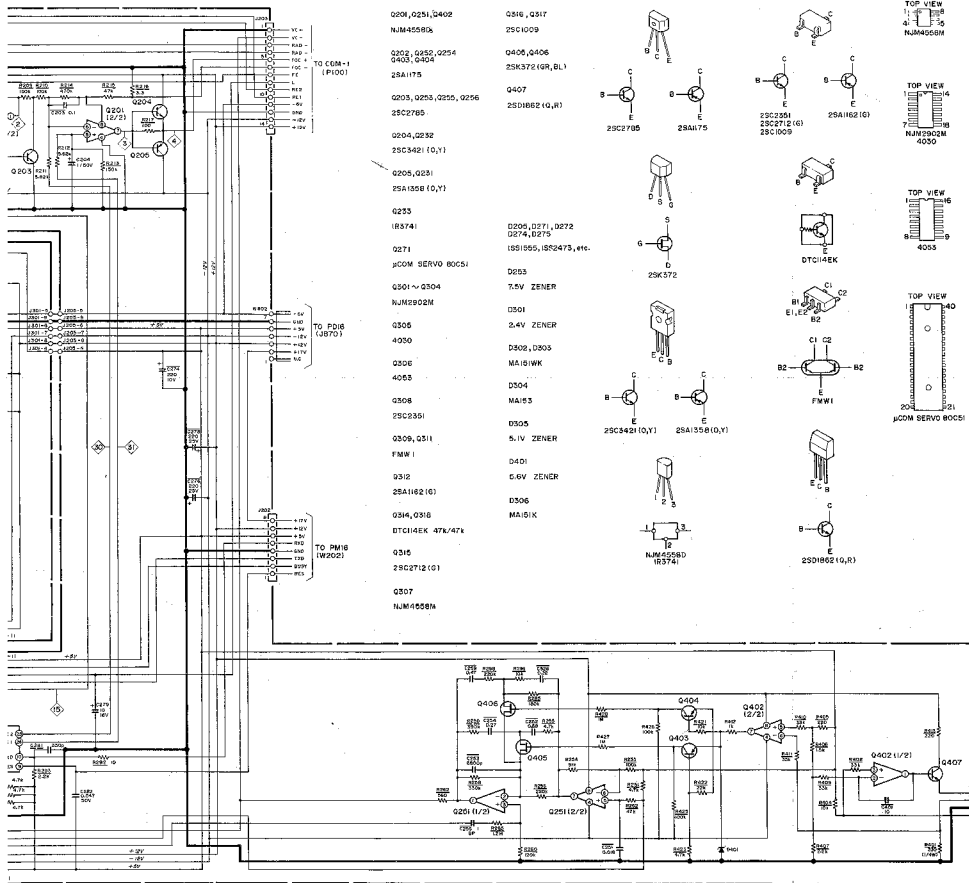

Q251, Q251, Q402	Q316, Q317	Q406, Q406	TOP VIEW
NJM455905	Z5C1009	Z5K372 (GR, BL)	4 1 2 3 5 NJM45591
Q202, Q252, Q254		Q407	TOP VIEW
Q303, Q404		Z5D1662 (Q, R)	1 2 3 4 NJM7302M 4030
Z5A1175		Z5C2785	TOP VIEW
Q205, Q255, Q255, Q256		Z5D1662 (Q, R)	1 2 3 4 NJM7302M 4030
Z5C2785		Z5A1175	TOP VIEW
Q204, Q232		Z5C2785	1 2 3 4 NJM7302M 4030
Z5C3421 (Q, Y)		Z5A1162 (Q)	TOP VIEW
Q205, Q251		Z5C2251	1 2 3 4 NJM7302M 4030
Z5A1162 (Q, Y)		Z5C2712 (Q)	TOP VIEW
Q233		Z5C1009	1 2 3 4 NJM7302M 4030
(R374)	Q206, Q271, Q272	DTC114EK	TOP VIEW
Q271	Z5C74, Q275	Z5K372	4055
µCOM SERV0 80C51	(S1)055, (S2)473, etc.	D301	TOP VIEW
Q301 ~ Q304	Q655	D301	1 2 3 4 NJM7302M 4030
NJM2902M	7.5V ZENER	D301	TOP VIEW
Q305	D301	D301	1 2 3 4 NJM7302M 4030
Q306	2.4V ZENER	D301	TOP VIEW
Q307	D302, D303	D301	1 2 3 4 NJM7302M 4030
Q308	MA15WK	D301	TOP VIEW
Z5C2351	D304	D301	1 2 3 4 NJM7302M 4030
Q309, Q311	D305	D301	TOP VIEW
FMW1	S1.V ZENER	D301	1 2 3 4 NJM7302M 4030
Z5A1162 (Q)	Q401	D301	TOP VIEW
Q316, Q316	6.6V ZENER	D301	1 2 3 4 NJM7302M 4030
DTC114EK 47K/47K	D306	D301	TOP VIEW
Q316	MA15K	D301	1 2 3 4 NJM7302M 4030
Z5C2712 (Q)		D301	TOP VIEW
Q307		D301	1 2 3 4 NJM7302M 4030
NJM45591		D301	TOP VIEW
		D301	1 2 3 4 NJM7302M 4030

Kind of Common Parts

- RESISTOR**
R*** (1) GD05 -- 140, Carbon film fixed resistor, ±5% 1/4W
R*** (2) GD05 -- 160, Carbon film fixed resistor, ±5% 1/6W
- C***** : **CERAMIC CAP.**
 (1) DD1 -- 370, Ceramic condenser, disc type (titan condenser) Temp. coeff. P350 ~ N1000 50V
C*** : **CERAMIC CAP.**
 (1) DK16 -- 300, High dielectric constant ceramic condenser, disc type (titan variable) Temp. chara. 2B4 50V
- C***** : **ELECTROLY CAP. (⚡)/FILM CAP. (≡)**
 (1) EA ----- 10, Electrolytic condenser, one-way lead type, tolerance ±20%
 (2) DF15 -- 350, Plastic film condenser, one-way type, Mylar, ±5% 50V

* In case of ordering the common parts, please establish the correct parts number of 10 figures by the procedure "ASSIGNMENT OF COMMON PARTS CODES"

"SERVICE INFORMATION IS FOR USE BY QUALIFIED PERSONNEL ONLY - ANY MISADJUSTMENT OR MISALIGNMENT MAY BE TREATED AS A NON-WARRANTY REPAIR BY ANY MARANTZ SERVICE CENTER."

NOTE ON SAFETY:
 Symbol ⚡ Fire or electrical shock hazard. Only original parts should be used to replace any part marked with symbol ⚡. Any other component substitution (other than original type), may increase risk of fire or electrical shock hazard.

Components and wiring are subject to change for modification without notice.

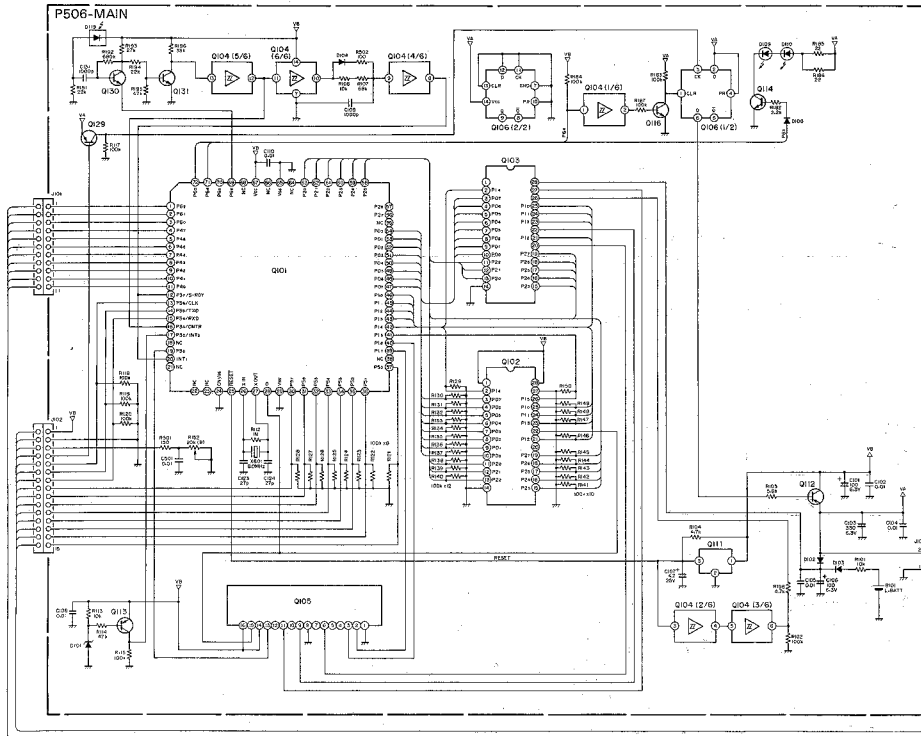

Q101 M50747-776FP	Q104 74HC14	Q111 PST530D	Q116, Q130, Q131 25C2712 (0, R1)	D101 5.0V ZENER	D106 MA151T
Q102 TC54256AF	Q105 74HC158	Q12, Q13, Q129 238162 (0, R1)	Q201 HD44790	Q102, Q105, Q104 D301	Q109, Q110 TLN105B
Q103 TC5565	Q106 74HC74	Q114 25C241K	Q202 HD44100H	MA-151K D304	D119 TP5703

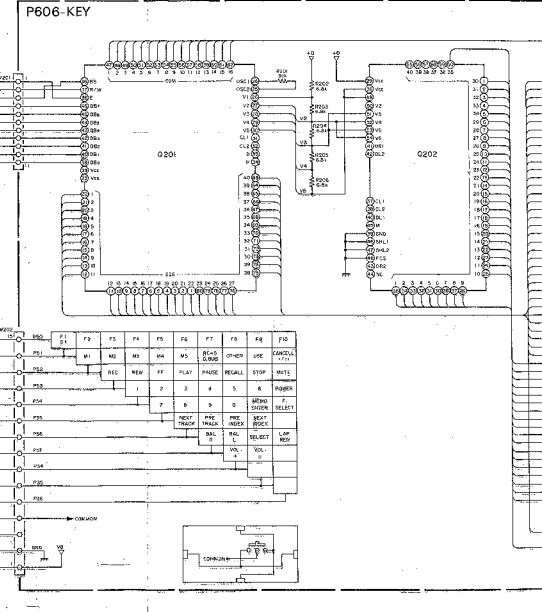

1	0104	Q111	Q116, Q130, Q131	D101	D106
1747-776FP	74HC14	PST520D	25C2712(16,R)	5.0V ZENER	MA51T
2	Q105	Q112, Q113, Q129	Q201	D102, D103, D104	D109, D110
4256AF	74HC39	25A162(16,R)	HD44780	MA-151K	TLN955B
3	Q106	Q114	Q202	D301	D119
565	74HC74	25C241K	HD44100H	MA-151K	TPST03

606-KEY

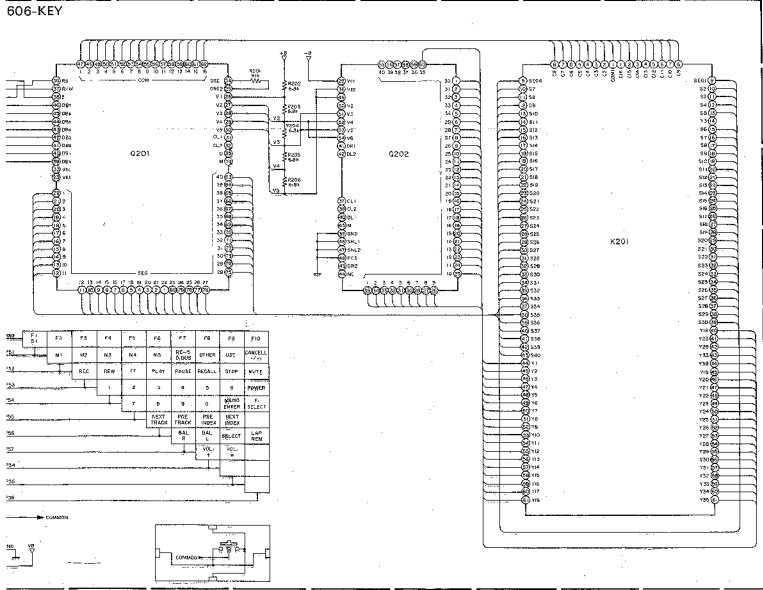

21	F1	F2	F3	F4	F5	F6	F7	F8	F9	F10
22	M1	M2	M3	M4	M5	M6	M7	M8	M9	M10
23	SEC	SEM	FF	PLIN	PRIND	MSALL	STR	WATE		
24										
25										
26										
27										
28										
29										
30										
31										
32										
33										
34										
35										
36										
37										
38										
39										
40										
41										
42										
43										
44										
45										
46										
47										
48										
49										
50										
51										
52										
53										
54										
55										
56										
57										
58										
59										
60										
61										
62										
63										
64										
65										
66										
67										
68										
69										
70										
71										
72										
73										
74										
75										
76										
77										
78										
79										
80										
81										
82										
83										
84										
85										
86										
87										
88										
89										
90										
91										
92										
93										
94										
95										
96										
97										
98										
99										
100										

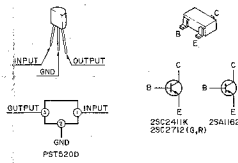
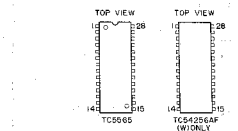
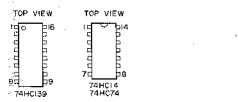
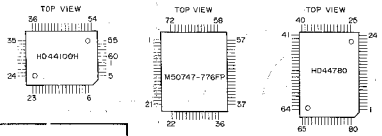

Kind of Common Parts

- RESISTOR**
- R*** (1) GD05 - 140, Carbon film fixed resistor, ±5% 1/4W
 - R*** (2) GD05 - 160, Carbon film fixed resistor, ±5% 1/6W
 - C*** : CERAMIC CAP.
 - (1) DD1 - 370, Ceramic condenser, disc type (titan condenser) Temp. coef. P350 - N1000 50V
 - C*** : CERAMIC CAP.
 - (1) DK16 - 300, High dielectric constant ceramic condenser, disc type (titan variable) Temp. chara. 2B4 50V
 - C*** : ELECTROLY CAP. (\square)/FILM CAP. (\square)
 - (1) EA - 10, Electrolytic condenser, one-way lead type, tolerance ±20%
 - (2) DF15 - 350, Plastic film condenser, one-way type, Mylar, ±5% 50V

* In case of ordering the common parts, please establish the correct parts number of 10 figures by the procedure "ASSIGNMENT OF COMMON PARTS CODES"

"SERVICE INFORMATION IS FOR USE BY QUALIFIED PERSONNEL ONLY - ANY MISADJUSTMENT OR MISALIGNMENT MAY BE TREATED AS A NON-WARRANTY REPAIR BY ANY MARANTZ SERVICE CENTER-"

NOTE ON SAFETY:

Symbol Δ Fire or electrical shock hazard. Only original parts should be used to replace any part marked with symbol Δ . Any other component substitution (other than original type), may increase risk of fire or electrical shock hazard.

Components and wiring are subject to change for modification without notice.